



**Pacific Gas and  
Electric Company**

# LETTER AGREEMENT NO. R1-13-74-PGE

**IBEW**



PACIFIC GAS AND ELECTRIC COMPANY  
LABOR RELATIONS AND HUMAN RESOURCES DEPARTMENT  
MAIL CODE N2Z  
P.O. BOX 770000  
SAN FRANCISCO, CALIFORNIA 94177  
(415) 973-4310  
STEPHEN RAYBURN  
DIRECTOR AND CHIEF NEGOTIATOR

INTERNATIONAL BROTHERHOOD OF  
ELECTRICAL WORKERS, AFL-CIO  
LOCAL UNION 1245, I.B.E.W.  
P.O. BOX 2547  
VACAVILLE, CALIFORNIA 95696  
(707) 452-2700  
TOM DALZELL  
BUSINESS MANAGER

March 10, 2014

**CXL Superseded By LA 18-20**

Mr. Tom Dalzell, Business Manager  
Local Union No. 1245  
International Brotherhood of  
Electrical Workers, AFL-CIO  
P.O. Box 2547  
Vacaville, CA 95696

Dear Mr. Dalzell:

Attached is the updated Job Definitions and Lines of Progression (JDLOP) for General Construction Station, Substation and Hydro, Exhibit VI-M, Section 600.13. The update integrates changes from General Negotiations and the results of various Letters of Agreement and precedent setting grievance decisions. It is not the intent of the parties to add or interpret any of integrated changes noted above and made a part of this agreement. In addition, any omission of relevant agreements is not intentional and shall be corrected.

Changes appear in italics. Also, attached is a revision mode copy showing additions in italics and deletions lined out. The documents prompting the changes are listed on the last page of the JDLOP.

While the parties have completed a comprehensive review, due to the length of time since the last update there may have been minor changes that were not noted in this current update. If either party becomes aware of a change that should be incorporated, the parties will review it and if so agreed, make the appropriate correction.

If you agree, please so indicate in the space provided below and return one executed copy of this letter to the Company.

Very truly yours,

PACIFIC GAS & ELECTRIC COMPANY

By:   
\_\_\_\_\_  
Stephen A. Rayburn  
Director and Chief Negotiator

The Union is in agreement.

LOCAL UNION NO. 1245, INTERNATIONAL  
BROTHERHOOD OF ELECTRICAL WORKERS, AFL-CIO

March 20, 2014

By:   
\_\_\_\_\_  
Tom Dalzell  
Business Manager

**PACIFIC GAS AND ELECTRIC COMPANY  
AND  
IBEW, LOCAL UNION 1245**

**JOB DEFINITIONS AND LINES OF PROGRESSION**

**for**

**GENERAL CONSTRUCTION**

**STATION, SUBSTATION AND  
HYDRO DEPARTMENT**

**Exhibit VI-M, Section 600.13**

**Updated *March 2014***

**Revised Book dated *January 1996***



## TABLE OF CONTENTS

INDEX.....	i
<i>APPRENTICE WATER SYSTEMS REPAIRPERSON</i> .....	8
<i>ELECTRICAL TECHNICIAN – G.C.</i> .....	7
G.C.FIELDPERSON – <i>Not Gas</i> .....	3
JOB DEFINITIONS AND LINES OF PROGRESSION.....	2
JOB DEFINITIONS.....	2
<i>LEAD MATERIALS HANDLER</i> .....	6
<i>MATERIALS HANDLER</i> .....	6
MISCELLANEOUS EQUIPMENT OPERATOR – <i>Not Gas</i> .....	4
REVIEW COMMITTEE NO. 1081-71-33 (Duties of Station Mechanics).....	10
<i>TECHNICAL CREW LEADER A – Not Gas (Per Letter Agreement 12-66)</i> .....	6
TECHNOLOGY.....	2
<i>TELECOMMUNICATIONS EQUIPMENT INSTALLER</i> .....	6
TRACTOR OPERATOR – <i>Not Gas</i> .....	5
<i>UTILITY WORKER – COMMUNICATIONS</i> .....	2
UTILITY WORKER.....	3
WAGE DIFFERENTIALS G.C. – REGIONS.....	2
<i>WATER SYSTEMS REPAIRPERSON (WSR)</i> .....	7
LETTER AGREEMENT 84-40 (Station Mechanic / Electrician).....	11
LETTER AGREEMENT R2-85-112 (Federal Communications Licensing).....	13
TELECOMMUNICATIONS EQUIPMENT INSTALLER TRAINING.....	15
<i>LETTER AGREEMENT R2-93-39 (Driver’s License Requirements)</i> .....	16
<i>LETTER AGREEMENT 97-80 (Co-Mingling within Hydro Generation)</i> .....	19
<i>LETTER AGREEMENT 97-140 (Co-Mingling)</i> .....	23

*LETTER AGREEMENT R1-99-57 (Titles 200/300 Co-Mingling – Appr. Electricians). 25*

*LETTER AGREEMENT R1-01-38 (Revises Item III of LA 84-40, Appr. Elec. Trng. Modules) ..... 27*

*LETTER AGREEMENT R1-04-11 (Switchman Certification)..... 37*

*LETTER AGREEMENT 07-43 (Appr. Electrical Tech Entrance Exam) ..... 39*

*LETTER AGREEMENT 08-37 (Titles 200/300 Co-Mingling ISTS Assignments)..... 49*

*LETTER AGREEMENT 09-31 (Appr. Communications Tech Entrance Exam) ..... 51*

*LETTER AGREEMENT 12-32 (Commercial Driver’s License Addendum)..... 53*

*LETTER AGREEMENT 93-69 (GC Classification Consolidation and LoP) ..... 59*

*LIST OF DOCUMENTS/REASONS PROMPTING CHANGES..... 67*

## INDEX

APPRENTICE COMMUNICATIONS TECHNICIAN.....	1, 7, 13, 14, 51, 52, 67
APPRENTICE ELECTRICAL TECHNICIAN .....	1, 39-42, 67
APPRENTICE ELECTRICIAN.....	1, 11, 13, 25, 27, 58, 67
APPRENTICE INSTRUMENT TECHNICIAN.....	1
APPRENTICE WATER SYSTEM REPAIRPERSON.....	1, 8-9
APPRENTICE WELDER.....	1
BACKHOE OPERATOR .....	1, 58
CARPENTER A.....	1, 58
CARPENTER B .....	1, 58
COMMUNICATIONS TECHNICIAN .....	1, 2, 3, 6, 7, 13, 14, 18
CRANE OPERATOR .....	1, 57
ELECTRICAL TECHNICIAN .....	1, 6, 7, 18, 37, 42, 67
ELECTRICIAN .....	1, 7, 10, 11, 12, 13, 18, 27, 37, 58
FIELDPERSON.....	1, 3, 4
GUNNITE NOZZLEMAN.....	1
INSTRUMENT TECHNICIAN .....	1, 18
LEAD MATERIALS HANDLER.....	1, 6, 67
MATERIALS HANDLER .....	1, 6, 67
MISCELLANEOUS EQUIPMENT OPERATOR .....	1, 4, 57
STATION MECHANIC .....	1, 10, 11, 18, 27, 58
SUBFOREMAN A .....	1, 58
TECHNICAL CREW LEADER A Not Gas .....	1, 2, 6, 67
TELECOMMUNICATIONS EQUIPMENT INSTALLER.....	1, 6, 7, 13, 14, 15, 67
TRACTOR OPERATOR.....	1, 5, 57
UTILITY WORKER .....	1, 3, 58
UTILITY WORKER – COMMUNICATIONS .....	1, 2, 3, 67
WELDER .....	1, 18, 58
WATER SYSTEMS REPAIRPERSON .....	7, 8, 67
WORKING FOREMAN B.....	1, 58
WORKING FOREMAN C.....	1, 58
WORKING FOREMAN D.....	1

## GC STATION, SUBSTATION, HYDRO LINE OF PROGRESSION

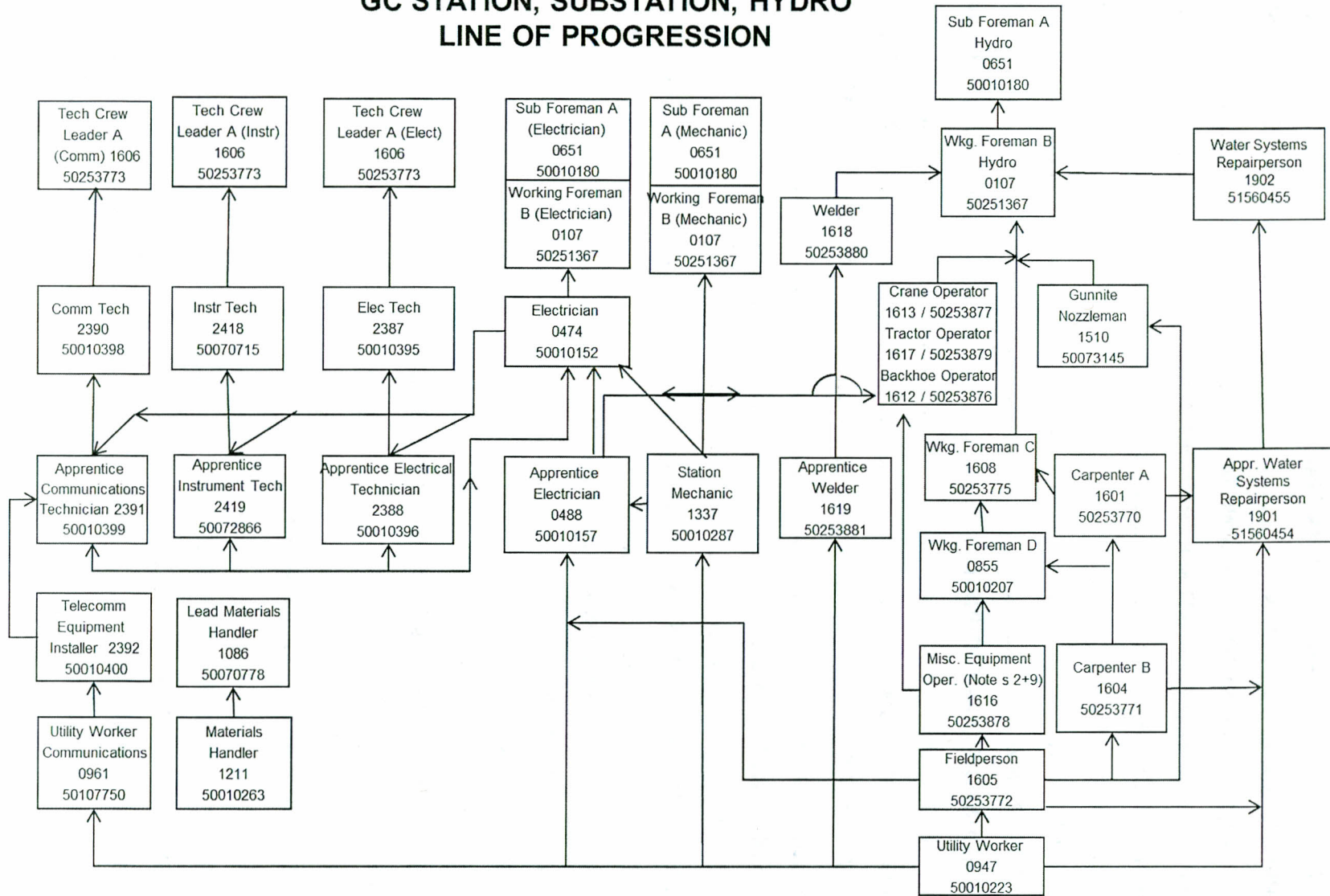



## GENERAL CONSTRUCTION

### STATION, SUBSTATION, HYDRO

#### JOB DEFINITIONS AND LINES OF PROGRESSION

#### WAGE DIFFERENTIALS G.C. – REGIONS

*Effective* January 1, 1991 and each year thereafter for the term of the Agreement, classifications that are comparable between General Construction and the Regions shall be adjusted to maintain a minimum 5% differential between such classifications.

Company and Union shall prepare a list of classifications that are considered to be comparable between General Construction and the Regions. Where necessary other non-comparable General Construction classifications shall also be adjusted annually to maintain historical relationship/separation between comparable and non-comparable GC classifications.

#### TECHNOLOGY

*The following job descriptions are* intended to be inclusive of duties appropriately assigned to the classification. The parties recognize that technological advances may raise questions about appropriate duties to assign to a classification in the future.

Therefore, Company and Union agree to establish a standing committee consisting of two representatives from Company and two representatives from Union to review new equipment and duties to determine the proper classification. Should such committee be unable to reach agreement on the appropriate classification to assign new equipment or duties to, the issue will be addressed pursuant to the provisions of Title 102. During the time such committee continues to discuss such issues, however, the time limits in Title 102 shall be suspended.

#### UTILITY WORKER – COMMUNICATIONS

##### **0961 (50107750)**

*May assist a qualified journeyman Technician in installing, testing, retiring, or removing the following equipment: microwave radios with antennas and transmission lines; data, telemetry and supervisory systems; dial exchanges; multi-plex; alarm systems; fiber optic systems; and battery and charging systems.*

*Under the general direction of a journeyman Technician may install, retire or remove telecommunications equipment including: physical components of moves, adds, and changes of computers, mobile radio transfers and installs; cell phone transfers; cable and fiber pulling; cable and wire termination; mounting of telecom equipment including ladder rack; wire DC power distribution; housekeeping duties.*

*Company may not exceed a ratio of 1 T200 Utility Worker to 10 T200 Communications Technicians and Crew Leaders, or 1 T300 Utility Worker to 10 T300 Telecommunications Technicians and Technical Crew Leaders. With Union agreement, Company may increase the number of Utility Workers.*

*As agreed in the 1999 General Negotiations, no Telecommunications Technician (T200) or*

*Communication Technician (T300) will be displaced, demoted or laid off as a result of establishing the Telecommunication Utility Worker (T200 or T300) position. In the event Title 206 or 306 is to be implemented, all Telecommunication and Communication Utility Workers shall be affected prior to Telecommunication Technicians or Communication Technicians.*

### **UTILITY WORKER**

**0947 (50010223)**

An employee whose principal duties consist of semi-skilled work while assisting a higher classified employee. Utility Workers assist in construction and maintenance and other miscellaneous semi-skilled work. With adequate training and under direction, may be required to: use hand tools, portable power tools, pavement breakers, spaders, tampers or compactors for work not requiring precision; perform pipe wrapping duties. A Utility Worker in Line Department may be permitted to learn to climb on the job in training for advancement, but shall not do line work.

### **G.C.FIELDPERSON – Not Gas**

**1605 (50253772)**

Employees in the *Fieldperson* classification, on a voluntary basis, may perform the duties of the former Powderman classification, upon obtaining the appropriate license.

Operates the following equipment:

- Earthworm
- Gas/electric hoist up to 15 HP
- Concrete Mixers 1/2 cu. yd. and under
- Concrete saws
- Tractor, Pneumatic Tired Loader, less than 1 1/2 cu. yds. with or without scrapper;
- Compactors, self-propelled, riding such as: Arrow Hydra-Hammer/compactor, Champion Stroke Hammer, Ohawa Hydra-Hammer/tamper, R&O Hydra-Hammer/compactor, Superhammer/compactor, or equivalent
- Tugger Air Hoist
- Air compressor up to 1000 C.F.M.
- Riding roller, self-propelled
- Street Sweeper, self-propelled, small
- Small Snow Cat, such as Bombadier; Two-axle truck of 12,000 lb. GVW or over;
- Small tiller type tractor or similar hauling unit, 30 HP and under
- Industrial material handling truck or tractor including lift and towing
- Pump tender
- Small trencher and other equipment 30 HP and under

Other equipment may be added to the above list by agreement between Company and Union.

G. C. *Fieldperson* may be required to perform the following duties:

- Performs metalman duties
- When working as a part of a crew, performs carpenter work such as simple form work, scaffolds, and other simple sawing and nailing of lumber
- When working as a part of a crew, performs plastic fusion such as socket joints, service tees and saddle connections on plastic pipe up to and including 4" in diameter. (Street Fitter classification shall be used when butt fusing or working alone.)



- When working as a part of a crew, performs miscellaneous pipe fitting on service connections/alterations. Such work is limited to threaded pipe under two-inch diameter, length of pipe and fittings not to exceed five feet in length including fitting(s) where the installation is a single domestic meter set without a manifold. (Where the installation requires pipe size of two-inch or larger, length including fitting(s) exceeds five feet, number of meters exceeds one, or a manifold is required, the Street Fitter classification shall be used.)

Class A California driver's license and/or other appropriate licenses and endorsements as required. Company shall pay all costs associated with obtaining and maintaining the appropriate drivers license and/or endorsements.

*Employees as of January 1, 1991* who do not currently possess a Class A California driver's license shall not be required to obtain such license, but may do so voluntarily, at Company expense. Should such employee not possess a Class A California Driver's License, such employee shall not be assigned to equipment requiring said licenses.

*Incumbent employees as of January 1, 1991*, in classifications higher than the *Fieldperson* who are subsequently affected by Title 306 will not be adversely impacted as a result of the *Fieldperson* licensing requirements.

Employees who enter the *Fieldperson* classification after the implementation date of January 1, 1991 will be required to possess the Class A California Driver's License and/or other appropriate licenses and endorsements as required. If after entering the classification, the employee can no longer meet the physical requirements for the Class A California Driver's License and/or other appropriate licenses and endorsements as required, but is otherwise qualified to perform the duties required of a *Fieldperson* on a regular basis, he/she will be accommodated as follows:

One unlicensed *Fieldperson* per 20 licensed *Fieldperson*. In computing this ratio, all *Fieldperson* will be included (both those classified at the time of implementation and *Fieldperson* entering the classification after implementation).

**MISCELLANEOUS EQUIPMENT OPERATOR – Not Gas**  
**1616 (50253878)**

Class A California driver's license and/or other appropriate licenses and endorsements as required. Company shall pay all costs associated with obtaining and maintaining the appropriate drivers license and/or endorsements. Incumbent employees who do not currently possess a Class A California driver's license shall not be required to obtain such license, but may do so voluntarily, at Company expense. Should such employee not possess a Class A California driver's license, such employee shall not be assigned the duties of the former Heavy Truck Driver, Line Driver or Special Driver classification.

Current employees as of January 1, 1991, in classifications higher than the Miscellaneous Equipment Operator who are subsequently affected by Title 306 will not be adversely impacted as a result of the MEO licensing requirements. Employees in classifications higher in the Line of Progression to the MEO may voluntarily elect to maintain a Class A driver's license, in which case all costs for obtaining and maintaining shall be paid by Company. An employee who progresses to a classification higher than MEO, in the event of a demotion pursuant to Title 306, shall be allowed up to 60 calendar days to obtain a Class A driver's license if such employee does not already possess such license.

Operates the following equipment:

- Dozer, smaller than D-4 or equivalent, with or without a side boom or equipment
- Rough terrain crane, Grove, Drott, Pettibone, up to and including 5 ton
- Loader, P.T., 1 1/2 thru 3 cu. yds., without sideboom
- Crane, swing, self-propelled, up to and including 5 ton
- Transport truck and trailer engaged in loading, transporting, and unloading heavy construction equipment throughout a geographic area or the company system
- Truck tractor operator coupled with one or more trailers
- Three-axle truck
- Truck with derrick and special body complete with tools and equipment to perform all phases of electric line work; *(Must have a minimum of 6 months experience in overhead line work before operating equipment in proximity to energized conductor/equipment.)*
- Boom truck without a personnel bucket under 10 tons; *(Must have a minimum of 6 months experience in Substation work before operating equipment in a substation.)*
- Hydrauger
- Gas/electric hoist over 15 HP
- Motor Patrol, less than 115 HP, when not grading to stake or grade
- Trencher, Boom Type, such as Ditch Witch, or equivalent
- Concrete Pump
- Tensioners and Pullers (see separate listing of pulling and tensioning equipment);
- Large Snow Cats
- Drill, Liner, self-propelled air track or equivalent
- Cross Country vehicles such as Dragon Wagon or equivalent
- Flume washer

Other equipment may be added to the above list by agreement between Company and Union.

**TRACTOR OPERATOR – Not Gas**  
**1617 (50253879)**

Operates the following equipment:

- Cat, D-4, D-5, D-6, D-7 and D-8
- Case, 850, 1150
- IH, TD-9, TD-15, TD-20, TD-25
- A. C., HD-6, HD-11, HD-16, HD-21
- Drott over 5 ton to 18 ton
- Crane, swing, self-propelled 5 to 10 ton P/M Model 25-20
- Loader, crawler mounted, 1-1/2 cubic yard and over
- Whirley, swing crane
- Motor patrol over 115 HP or when grading to stakes or grade;
- Tractor, crawler side boom, 10 ton and over

Other equipment may be added to the above list by agreement between Company and Union.



**MATERIALS HANDLER**

**1211 (50010263)**

*Receives, stores, packages and ships material used by the Station Construction Department Technical Services Group. May be required to operate material handling equipment and to use a typewriter or data terminal. The employee must have a valid Class C California Driver's License to transport material between the facility and jobsite.*

*Pre-Requisite:*

*Qualified on the EEI Clerical Aptitude Test Battery (CLAPT) October 24, 1990 and December 31, 1997, or*

*Qualified on the PSI Clerical Test Battery on or after January 1, 1998.*

**BEGINNER'S CLASSIFICATION**

**LEAD MATERIALS HANDLER**

**1086 (50070778)**

*Directs and performs duties related to materials related office procedures: Receives, stores, packages and ships material used by the Station Construction Department Technical Services Group. May be required to operate material handling equipment and to use a typewriter or data terminal. The employee must have a valid Class C California Driver's License to transport material between the facility and jobsite.*

**TECHNICAL CREW LEADER A – Not Gas (Per Letter Agreement 12-66)**

**1606 (50253773)**

*Supervises crews containing Electrical Technicians and Communication Technicians. Supervises highest level of technical jobs and may work with a crew under his supervision.*

**TELECOMMUNICATIONS EQUIPMENT INSTALLER**

**2392 (50010400)**

*An employee who performs but is not necessarily limited to the following:*

*Installing - retiring or removing telecommunications equipment including:*

- 1. Cable and wire terminations and testing*
- 2. Equipment racks*
- 3. Equipment shelves*
- 4. Seismic and support bracing*
- 5. Wire DC Power Distribution*
- 6. Telephone and telephone key equipment*
- 7. Safe operation of hand and power tools*
- 8. Splicing cables and wire*
- 9. Housekeeping duties*

*In addition, the Installer may assist a qualified Technician in installing, testing, retiring or removing the following equipment:*

- 1. Mobile and microwave radios with antennas and transmission lines*
- 2. Data, telemetry and supervisory systems*

3. Dial exchanges
4. Multi-plex
5. Alarm Systems
6. Fiber optic systems
7. Battery and charging systems

Without the supervision and direction of a licensed technician, an installer will not be allowed to:

*Perform specialized final testing procedures or put radio transmitters on the air.*

*The number of Telecommunications Equipment Installer will be limited to 35% of the total number of Communications Technicians, Appr. Communication Technician and Technical Subforeman as previously agreed to in Letter of Agreement 85-112. It is not the intent to bypass or under utilize the Appr. Communication Technician classification.*

*Must pass Physical Test Battery (PTB) and Industrial Skills Test (IST-- Letter Agreement 10-13).*

**ELECTRICAL TECHNICIAN – G.C.**  
**2387 (50010395)**

*An employee who, without direct supervision, performs programming, installation, calibration, testing, troubleshooting, maintenance and installation of electromechanical, solid state and microprocessor protective relays, automation and control systems. This includes synchronized end to end protection systems testing.*

*Performs applicable testing and troubleshooting, and apply configurations to remote control and data acquisition systems (i.e. SCADA, EMS). Responsible for completing all applicable documentation and test reports required to meet internal and Federal, State and local regulatory compliance.*

*Plans and schedules work, including submitting clearance applications to the Operations Control Center. May be assigned to train and direct Electrical Technician apprentices. May direct Electricians. Makes field revisions to engineering documents and drawings. Responsible for testing and commissioning integrated and non-integrated electrical systems, i.e. switchgear, network relays.*

*Must have background of Electrical Technician apprenticeship.*

*Assignments may include duties performed to the protection system associated communications equipment.*

*Class C drivers' license required per LA 93-39.*

**WATER SYSTEMS REPAIRPERSON (WSR)**  
**51560455**

*An employee who is engaged in the construction, maintenance, and repair of all types of Hydro water system structures and related facilities and equipment, including water collection and domestic water systems. Such employee drives trucks and operates mechanical equipment such as sno-cat, tractor-grader, backhoe, loaders, excavators and all equipment for general hauling, bulldozing, road maintenance, excavation and other similar work. If required, must possess a Commercial Class A Driver's License and if qualified, may be assigned duties associated with a Blasting License, Tunnel Safety License and/or Treatment Plant Operator License. Must make welds and do general leveling with surveyor's level, as required, have general working knowledge of*



carpentry and concrete practices, have a good working knowledge of safe rigging practices, be proficient in the use of all types of hand and power tools and in the operation of mechanized equipment associated with this work. Increased technology and work practices may require use of a computer, when qualified. May be assigned other work of similar nature as the occasion requires, including building maintenance of hydro facilities. The employee's background of experience and the successful completion of formal training must be such as to qualify him/her to perform this work with skill and efficiency.

Legacy Code	SAP Job Code	Next Lower Classifications
1901	51560455	Appr. Water Systems Repairperson – GC*
2067	50010360	Appr. Water Systems Repairperson*

Legacy Code	SAP Job Code	Same or Higher Classifications
0107	50251367	Working Foreman B – Non-Climbing
0830	50010200	Water Systems Crew Leader
1036	50010232	Meteorological Instrumentperson
--	51560455	Water Systems Repairperson - GC
2069	50070804	Water Systems Repairperson - Helms
2066	50072890	Water Systems Repairperson - UN - Helms
2070	50010362	Water Systems Repairperson
2068	50010361	Water Systems Repairperson - UN

\*Must have 30 months in line of progression.

**APPRENTICE WATER SYSTEMS REPAIRPERSON  
51560454**

An employee engaged in performing Water Systems Repairperson work as an assistant to or under the general direction of a Repairperson or other higher classified employee. In order to gain experience for advancement to Water Systems Repairperson, such employee may work alone or under indirect supervision on jobs for which the employee has been trained and instructed. The employee's educational and general qualifications must be such that the employee is considered capable of attaining journeyman status.

Legacy Code	SAP Job Code	Next Lower Classifications
0418	50073023	Truck Driver - Water
0921	50072845	Utility Worker - Drum
0922	50010214	Utility Worker - Helms
0923	50010215	Utility Worker - Materials - Elec. Maintenance

Legacy Code	SAP Job Code	Same or Higher Classifications
1905	50072833	Water Treatment Plant Operator
2067	50010360	Appr. Water Systems Repairperson
--	51560454	Appr. Water Systems Repairperson - GC
1601	50253770	Carpenter A-Not Gas

0925	50010216	Utility Worker - Elec. Maintenance
0945	50070766	Utility Worker - Water
1824	50010347	Utility Operator - Hydro
0926	50072843	Utility Worker - Electric Operating
1037	50070773	Asst. Meteorological Instrumentperson
1898	50010353	Water System Operator- PIO
0947	50010223	Utility Worker GC
1605	50253772	Fieldperson GC – Not Gas

1604	50253771	Carpenter B – Not Gas
1616	50253878	Miscellaneous Equipment Operator-Not Gas



**REVIEW COMMITTEE NO. 1081-71-33**  
**General Construction Grievance No. D.Gr/C 3-70-18**  
**Duties of Station Mechanics**

August 5, 1976

Mr. C. GORDON SPARROWE, Chairman  
General Construction  
Joint Grievance Committee

The above-subject grievance has been discussed by the Review Committee and is being returned to the Department Joint Grievance Committee for settlement in accordance with the following:

The issue concerns the assignment of a Station Mechanic removing grounds from taps on the de-energized side of an open 115 kv disconnect switch mounted on a steel structure at the San Rafael Substation on July 21, 1970. The Station Mechanic was instructed by the Foreman to go up the ladder, tie it off, while standing on the ladder, remove the grounds hanging down in the proximity of the ladder. He was told that the taps were energized on the far side of the structure. The Station Mechanic went up the ladder, tied it off, but at this point instead of following instructions, continued on up the ladder onto the structure, attempted to walk between the insulator stacks of the open switch. The switch arced, blew him off the structure, and he was injured. Union filed the grievance in his behalf alleging that Station Mechanics are not qualified to perform such tasks alleging that Station Mechanics are not qualified to perform such tasks and should not be allowed to perform line work or Electrician's work.

The key question is one of whether Station Mechanics are qualified by training and experience to perform this type of work in a safe manner. In reviewing the record and in subsequent discussions with the General Construction Department and Company's Safety, Health and Claims Department, it was determined that General Construction field employees in Station Construction undergo instructions on grounding procedures at least twice yearly. The Department has detailed instructions relative to grounding procedures, specifically, general operating instructions, Pages 15-17, Article 9, the Foreman's Manual, Grounding Procedure, Pages 109-110, and Substation Bulletin "0-4." In view of the overall work assignments of Station Mechanics and the Department's procedures relative to grounding procedures, the Review Committee is of the opinion that the contractual violation did not occur in this incident, and assignments of this nature are proper providing the individual employees are qualified by training and experience.

When a settlement is reached by the Joint Grievance Committee, the Review Committee should be sent a copy of the final disposition.

D. J. BERGMAN, Chairman  
Review Committee

L. N. FOSS, Secretary  
Review Committee

DJB:rt0

cc: CHSedam  
IWBonbright  
LVBrown  
JAFairchild  
PMatthew  
Personnel Managers

**Note: The Industrial Skills Test (IST) has replaced the Arithmetic Computation Test (ACT) (Letter Agreement 10-13). Item III is revised by LA R1-01-38.**

**LETTER AGREEMENT  
84-40-PGE**

February 6, 1985

Local Union No. 1245  
International Brotherhood of  
Electrical Workers, AFL-CIO  
P. O. Box 4790  
Walnut Creek, CA 94596

Attention: Mr. J. K. McNally, Business Manager

Gentlemen:

Attached is Exhibit I, the revised Station Construction Department's Line of Progression. In conjunction with this LOP revision, Company proposes to incorporate revisions herein to allow Station Mechanics to become Apprentice or Journeyman Electricians.

I. The progression for Station Mechanics who wish to be considered for change of classification to Apprentice Electrician or Electrician may proceed, with approval of the Manager and with a successful score on the ~~Arithmetic Computation Test (ACT)~~ *Industrial Skills Test (IST)*, *Letter Agreement 10-13*.

II. Re-classification to Apprentice Electrician is initiated by request of the Mechanic. Subject to meeting the requirements of I above, the reclassification will proceed as follows:

- a. First through sixth step Mechanic shall reclassify from the present wage step to the same wage step in the Apprentice Electrician Program.
- b. Regardless of the Apprentice Electrician step that the Mechanic enters in the Apprentice Training Program, the step will be held until the Standards of Achievement for the academic and physical skills of that step have been met.

~~III. Re-classification to Electrician is initiated by request of a top step Mechanic. To qualify for this method of re-classification, the Mechanic must have, in addition to I above, the following prerequisites which can be completed without a formal declaration of intent to change status to Electrician. (Revised by LA R1-01-38)~~

- a. Been at the top wage step of Mechanic for at least two years.
- b. Passed the following Supplemental Academic Program courses successfully:
  - B-10 Basic Math
  - B-16 Print Reading - PGandE Drawings
  - B-20 Safety
  - B-25 Operating Procedures
  - B-30 Receive and Store
  - B-35 Introduction to Electricity and Electronics
  - B-75 Field Testing
  - E-10 D-C Theory

- E-15 A-C Theory
- E-16 Power Sources and Electric Motors
- E-26 Schematics and Diagrams
- E-30 Transformers and Vectors

If the Mechanic decides to reclassify to an Electrician, a formal application shall be submitted through the Foreman to the manager. If application is approved, successful completion of the following requirements is mandatory before reclassification is final and before payment of the Electrician wage rate.

- c. Basic Electricity School in Emeryville.
- d. Six months of "On-the-Job" training, including the following minimum requirements, under the supervision of an Electrician or other qualified person:
  - 1. Wire Pulling 2 weeks
  - 2. Terminating 5 weeks
  - 3. Layout of Switchboards 2 weeks
  - 4. Wiring of Switchboards 5 weeks
  - 5. Field Tests:
    - Transformer Ratio and Polarity 2 tests
    - Dielectric - Oil 2 tests
    - Megger 2 tests
    - Ground Resistance 2 tests
    - High Voltage Detector 2 tests

In the event that more Mechanics wish to become Electricians than there are openings, Company seniority will be the prevailing factor.

If you are in accord with the foregoing and the attached Exhibit I and agree thereto, please so indicate in the space provided below and return one executed copy of this letter to Company.

Yours very truly,

PACIFIC GAS AND ELECTRIC COMPANY

By /s/ I. W. Bonbright  
 Manager of Industrial Relations

The Union is in accord with the foregoing and it agrees thereto of the date hereof.

LOCAL UNION NO. 1245, INTERNATIONAL  
 BROTHERHOOD OF ELECTRICAL WORKERS,  
 AFL-CIO

March 26, 1985

By /s/ Jack McNally  
 Business Manager



**Note: Telecommunications Equipment Installer job description modified by Letter Agreement R2-90-40-PGE. See job description. The Industrial Skills Test (IST) has replaced the Arithmetic Computation Test (ACT) (Letter Agreement 10-13).**

**LETTER AGREEMENT  
R2-85-112-PGE**

January 14, 1986

Local Union No. 1245  
International Brotherhood of  
Electrical Workers, AFL-CIO  
P. O. Box 4790  
Walnut Creek, CA 94596

Attention: Mr. Jack McNally, Business Manager

Gentlemen:

Pursuant to Section 304.4 of the Physical Agreement, Company proposes to establish the classification of Telecommunications Equipment Installer in the General Construction Station Department.

This classification shall be permanently assigned to and regularly perform, without direct supervision, installation of telecommunication systems, including but not limited to: dial exchanges, telephone station equipment, power line carriers, microwave, radio, supervisory and telemetering equipment. The employee holding this classification shall have a background of apprenticeship and experience such as to qualify him to perform these duties with skill and efficiency.

It is proposed that the wage rate be identical to the two-year step of the General Construction Apprentice Communication Technician, Class code No. 2391. Attached as Exhibit I is the proposed line of progression.

The majority of the telecommunication work performed by General Construction does not require licensing by the Federal Communications Commission. It is therefore proposed to eliminate the second-class license or other Company-approved certification as a prerequisite to entering the Communication Technician apprenticeship. Those employees who, subsequent to entering the training program, obtain such certification shall, at their option, progress to Communication Technician in accordance with the Training Guidelines and the General Construction Master Apprenticeship Agreement. Those employees who do not obtain such certification shall, at the conclusion of 24 months in the program, be reclassified to Telecommunications Equipment Installer at the same wage rate. Employees who enter the Telecommunications Equipment Installer classification will be required to provide the tools required of a 24-month Apprentice Communication Technician.

For entry into the Apprentice Communication Technician classification, employees from the Apprentice Electrician, Electrician, or other classifications to this line of progression will be required to pass the Apprentice Communication Technician entry exam as well as any applicable aptitude tests, such as the Physical Pre-employment Test and the Arithmetic Computation Test *Industrial Skills Test (IST)*, *Letter Agreement 10-13*. Qualified outside candidates for the Apprentice Communication Technician, Communication Technician, and Telecommunications Equipment Installer will also be required to pass the Apprentice Communication Technician entry exam, which



is the same exam given by the G.O. Telecommunications Department. Such employees will be required to pass the above- named aptitude tests. Outside candidates who pass the Apprentice Communication Technician entry examination will be placed either in a appropriate wage step of the apprenticeship, based on current skills and knowledge, or at the Telecommunications Equipment Installer wage rate provided the employee is fully qualified and requires no further training.

The number of Telecommunications Equipment Installer will be limited to thirty- five percent (35%) of the total number of Communication Technicians. As an example, at present, there are 125 Communication Technicians. Therefore, 35 percent of 125 results in 43.75 for a total of 43 Telecommunication Equipment Installers.

If you are in accord with the foregoing and attachment and agree thereto, please so indicate in the space provided below and return one executed copy of this letter to the Company.

Yours very truly,

PACIFIC GAS AND ELECTRIC COMPANY

By /s/ I.W. Bonbright  
Manager of Industrial Relations

The Union is in accord with the foregoing and attachment and it agrees thereto as of the date hereof.

LOCAL UNION NO. 1245, INTERNATIONAL  
BROTHERHOOD OF ELECTRICAL WORKERS,  
AFL-CIO

Feb. 21 , 1986

By /s/ Jack McNally  
Business Manager

**TELECOMMUNICATIONS EQUIPMENT INSTALLER**

**36-MONTH TRAINING SCHEDULE**

---

HOME STUDY	HOURS
B-10 Basic Math	24
B-20 Safety	12
B-40 Rigging	16
B-55 Hand Tools	12
B-35 Introduction to Electricity and Electronics	9
B-56 Power Tools	24
B-65 Conduit Cable Wire	22
B-25 Operating Procedure	18

---

"ON THE JOB" ASSIGNMENTS	HOURS
1. Safety	48
2. Erect Microwave Terminals	80
3. Erect Microwave Antennas	80
4. Wiring Standards Microwave Equipment	40
5. Wiring Standards Multiplex Equipment	40
6. Wiring Standards Dial Equipment	120
7. Wiring Standards Station Equipment	100
8. Wiring Standards Cable Splicing	40
9. Wiring Standards Battery Systems	40
10. Install Dial Equipment Exchanges	150
11. Install Dial Equipment Key Telephones	120
12. Install Dial Equipment Telephones	80
13. Install Multiplex Equipment	40
14. Install Data Systems Alarm Equipment	20
15. Install Data Systems Telemetry	20
16. Install Data Systems Supervisory	20
17. Mobile Radio Installation	80

**LETTER AGREEMENT  
R2-93-39-PGE**

January 14, 1994  
Local Union No. 1245  
International Brotherhood of  
Electrical Workers, AFL-CIO  
P.O. Box 4790  
Walnut Creek, CA 94596

Attention: Mr. Jack McNally, Business Manager

Gentlemen:

In 1992, Company and Union established Ad Hoc Negotiations 92-1 to review the current licensing requirements for physical and clerical positions not covered by the Commercial Driver's License Addendum (CDLA) Agreement.

Company and Union have jointly established the attached list of license requirements that will be used in filling positions through the job bidding and transfer system. Also attached are classifications filled under Title 305 where a license is required.

In addition to the attached licensing requirements, the following administrative guidelines are established:

1. Accommodation of Current Employees Without Licenses

Employees who are currently being accommodated in a position requiring a license will continue to be accommodated unless there is a significant change in local operating conditions which prevent the accommodation.

2. Future Accommodation of Employees With Suspended Licenses

Employees who currently possess a license, but have their license temporarily suspended or who are temporarily unable to drive for other reasons, will be considered for accommodation on a case by case basis taking into consideration local operating conditions and the length of the suspension or inability to drive. Accommodation decisions will be subject to the grievance procedure.

3. Revoked Licenses

Employees who currently possess a license and are in a classification requiring a license may be removed from the classification if their license is revoked.

4. Apprentice Clarification

Those employees in apprentice classifications for which the journeyman is required to have a driver's license will have their status reviewed by the Apprenticeship Committee for possible removal from the apprenticeship if their license is revoked.

5. "A" License Requirements

If the "A" license requirement shown on the attachment is no longer required, the parties will meet to determine the requirements.

6. Geysers Power Plant

A license requirements for the Geysers Power Plant was discussed. No agreement was reached.

*If you are in accord with the foregoing and attachments and agree thereto, please so indicate in the space provided below and return one executed copy of this letter to the Company.*

*Very truly yours,*

*PACIFIC GAS & ELECTRIC COMPANY*

*By /s/ David J. Bergman  
Director and Chief Negotiator*

*The Union is in accord with the foregoing and attachments and it agrees thereto as of the date hereof.*

*LOCAL UNION NO. 1245, INTERNATIONAL  
BROTHERHOOD OF ELECTRICAL WORKERS, AFL-CIO*

May 1 , 1995

*By /s/ Jack McNally  
Business Manager*



TITLE 300 POSITIONS

January 14, 1994

<u>Class Code</u>	<u>Classification</u>	<u>Required License</u>
0163	Carpenter A	C
0164	Carpenter B	C
0243	Senior Field Clerk <sup>(1)</sup>	C
0245	Routine Field Clerk <sup>(1)</sup>	C
0246	First Field Clerk <sup>(1)</sup>	C
0275	Partsman <sup>(1)</sup>	C
0276	Field Partsman	C
0405	Driller <sup>(1)</sup>	A
0434	Special Driver (SC)	A
0466	Electrician <sup>(1)</sup>	C
0474	Electrician <sup>(1)</sup>	C
0525	G.C. Fieldman	A
0580	Street Fitter <sup>(1)</sup>	C
0630	Labor Foreman	C
0644	Tech. Subforeman A <sup>(1)</sup>	C
0645	Tech. Subforeman B <sup>(1)</sup>	C
0650	Subforeman A	C
0653	Subforeman B	C
0776	Field Partsman	C
0844	Working Drilling Foreman	A
0850	Working Foreman A	C
0853	Working Foreman B	C
0854	Working Foreman C <sup>(1)</sup>	C
0885	Garageman Field	C
1006	Field Mechanical Inspector <sup>(1)</sup>	A
1007	Mechanical Inspector <sup>(1)</sup>	A
1085	Materials Leadman <sup>(1)</sup>	C
1210	Materialsman	C
1255	Equipment Mechanic <sup>(1)</sup>	A/C
1267	Lead Field Garage Mechanic <sup>(1)</sup>	A/C
1270	Field Garage Mechanic A <sup>(1)</sup>	A/C
1275	Field Garage Mechanic B <sup>(1)</sup>	A/C
1276	Field Garage Mechanic C	A
1301	Gas Mechanic <sup>(1)</sup>	C
1310	Hydro/Station Mechanic <sup>(1)</sup>	C
1337	Station Mechanic <sup>(1)</sup>	C
1345	Mechanic Lead <sup>(1)</sup>	A
1510	Gunite Nozzleman	C
1515	Backhoe Operator	C
1597	Crane Operator <sup>(1)</sup>	A
1646	Misc. Equipment Operator	A
1690	Hole Digger Operator <sup>(1)</sup>	A
1840	Tractor Operator <sup>(1)</sup>	A
1924	Painter A <sup>(1)</sup>	C
1925	Painter B <sup>(1)</sup>	C
2390	Communication Technician <sup>(1)</sup>	C
2392	Telecommunication Installer <sup>(1)</sup>	C
*2400(2387)	Electrical Technician	C
2413	Gas Technician	C
2418	Instrument Technician	C
2520	Towerman	C
**2617	Welder - Station <sup>(1)</sup>	B/C
2617	Welder - Gas <sup>(1)</sup>	B

(1) Depending upon local operating conditions.

\*GC Electrical Technician classification code is 2387. Appears there was an error in the original letter agreement.

\*\* GC Welder-Station title and class code were subsequently changed to 1618 Welder – Not Gas.

**LETTER AGREEMENT  
97-80-PGE**

*Updated by LA R1-98-91: Pursuant to the 94-53 Hydro Committee recommendation to modify Letter of Agreement 97-80-PGE, Local Union 1245 proposes to provide an additional daily allowance of \$9.25 to the provisions of 302.10 as applied under the "Headquartering" section of Letter of Agreement 97-80-PGE.*

*May 1, 1997*

*Local Union No. 1245  
International Brotherhood of  
Electrical Workers, AFL-CIO  
P.O. Box 4790  
Walnut Creek, CA 94598*

*Attention: Mr. Jack McNally, Business Manager*

*Gentlemen:*

*The Hydro Generation 94-53 Committee discussed the benefits of clarifying the relationship of Title 200 and 300 employees within Hydro Generation. The committee's goal was to become "best in class" by establishing a co-mingling agreement. Hydro Generation can maintain a stable Title 200 and 300 work force by leveling the work load, leveraging the knowledge and expertise of the work force and providing flexibility to deploy talent to the highest priority work. The subcommittee members are: Tom Moore, John Sandhofner, Tom Carrier, Mike Sigmen, Terry Marymee, Shirley DeLucchi, John Perrault, Bill Tomei, Craig Hill, Sam Tamimi, and John Moffat.*

*The intent of this proposal is to retain qualified personnel, preserve Title 200 and 300 integrity, to assign complete work packages and supplement crews.*

*The Company proposes to establish a co-mingling agreement for Hydro Generation based on the following 94-53 Committee recommendations. It is further proposed that this proposal be reviewed in one year following implementation.*

*This proposal will address the following areas: Job Assignments, Headquartering, Staffing Upgrades, Overtime, Tools and Inclement Weather.*

*Job Assignments:*

*Overall job responsibility shall be clearly established before co-mingling begins. A job assignment sheet shall be completed which identifies the following: (Sample Attached)*

- ◆ Lead Responsible Supervisor*
- ◆ Defined job scope*
- ◆ Estimated job duration*
- ◆ Crew members names and classifications*

*Lead Supervisor shall be responsible for job safety which will include IIPP and Emergency Response Plan. Both Title 200 and 300 supervisors will inform their respective co-mingled employees of the information provided on the job assignment sheet.*

*Headquartering:*



There will be no change to Section 202.19 (regular headquarters). Section 302.10 will be modified to accommodate five Hydro headquarters which do not currently meet lodging and restaurant requirements as described in Exhibit XV. (This modification also applies to non co-mingled assignments.)

The five Hydro headquarters are:

- ◆ **Manton**
- ◆ **Rodgers Flat**
- ◆ **Alta**
- ◆ **Tiger Creek**
- ◆ **Auberry**

Title 200/300 employees will observe the same reporting times at the above mentioned headquarters. (This also applies to non co-mingled crews). Title 300 employees, who by reporting to one of the five mentioned headquarters places them in zone 5 (Title 301.4(a)), will be paid an additional allowance to commute from the closest community that meets the requirements in Exhibit XV. The allowance is based on the same schedule found in Section 301.4(a). Employees who are eligible have the option of declining the additional allowance in lieu of driving a company vehicle from the closest community. Changes to this arrangement may be made in advance by mutual consent of supervisor and eligible employee.

Title 300 employees shall be assigned to co-mingled crews by their supervisor by classification as needed.

Title 200 employees will need to sign an annual co-mingling list by December 15 of the previous year to facilitate equitable job assignments. Title 200 employees in a new headquarters will be given an opportunity to sign the annual co-mingling list when they first report. They will be credited average days in their classification. Assignment of Title 200 employees to the crew will be based on specific classifications needed for the defined project. First assignment on any given year is by seniority of employees on the annual co-mingling list. Co-mingling work will be distributed among employees in the same classification on the list as equitably as practical. Listed employees will be credited with refused days.

If there is an insufficient number of Title 200 volunteers available, co-mingling assignment will be made by the appropriate supervisor by classification in reverse seniority until all the necessary positions are filled.

Upgrades given in the following order:

- ◆ Senior qualified person within co-mingled crew within live of progression of the Title holding the job assignment.
- ◆ Senior qualified person within headquarters (T200 on list) or POA (T300) within Title holding job assignment.
- ◆ Senior qualified employee within co-mingled crew, regardless of Title holding job assignment.
- ◆ Senior qualified T200/300 person available.

#### **Overtime Issues (Title 208, 308,212)**

Overtime will be offered in the following order for the defined job scope:

- ◆ To the co-mingled crew (the intact work crew has "First Right of Refusal").
- ◆ To the Title crew who has the assignment (if T200, must be on list).
- ◆ To all remaining employees at the headquarters holding job assignment.
- ◆ To Title 200/300 employees at the headquarters or POA.
- ◆ Involuntary overtime will be assigned to the crew holding the job assignment.

#### **Sharing**

Tools, Equipment and Facilities may be shared between Title 200/300 crews with concurrence of local supervision.





CO-MINGLING  
JOB ASSIGNMENTS

Supervisor \_\_\_\_\_

Job Location: \_\_\_\_\_

Job Scope \_\_\_\_\_

Estimated Time: Start \_\_\_\_\_ End \_\_\_\_\_

<u>Crew:</u>	<u>Name</u>	<u>Classification</u>	<u>Title 200/300</u>
--------------	-------------	-----------------------	----------------------

Post on Bulletin Board  
cc: Local Business Representative

Attachment





*The Company is in accord with the foregoing and attached and agrees thereto.*

*PACIFIC GAS & ELECTRIC COMPANY*

12/10, 1997

By: s/David J. Bergman  
*David J. Bergman*  
*Director and Chief Negotiator*



# LETTER AGREEMENT NO. R1-99-57



PACIFIC GAS AND ELECTRIC COMPANY  
INDUSTRIAL RELATIONS DEPARTMENT  
2850 SHADELANDS DRIVE, SUITE 100  
WALNUT CREEK, CALIFORNIA 94598  
(925) 974-4104

INTERNATIONAL BROTHERHOOD OF  
ELECTRICAL WORKERS, AFL-CIO  
LOCAL UNION 1245, I.B.E.W.  
P.O. BOX 4790  
WALNUT CREEK, CALIFORNIA 94596  
925-933-6060

RICK R. DOERING, MANAGER  
AND CHIEF NEGOTIATOR

JACK McNALLY, BUSINESS MANAGER

February 3, 2000

Local Union No. 1245  
International Brotherhood of  
Electric Workers, AFL-CIO  
PO Box 4790  
Walnut Creek, CA 94598

Attention: Mr. Jack McNally, Business Manager

Dear Mr. McNally:

The Company and Union have recently discussed the training of Apprentice Electricians (Electric Maintenance) and agree that some Title 200 and Title 300 Apprentice Electricians have not had an opportunity to be exposed to certain tasks due to a lack of that type of work in their area. The following guidelines are proposed for making temporary training assignments for designated tasks. The intent of this agreement is to keep training assignments away from the apprentice's designated headquarters as short as practical.

1. For training purposes, the Company may temporarily assign Title 200 Apprentices to Title 300 job locations, Title 300 Apprentices to Title 200 headquarters or Title 200 Apprentices to another Title 200 headquarters. These assignments will not be made to avoid the payment of overtime to the regular crew members or to rectify staffing deficiencies. It is not intended that Title 200 Apprentice Electricians could be assigned to hydro, steam, or nuclear job locations.
2. Title 200 Apprentices assigned to Title 300 crews shall work within the Title 200 Section of the Agreement during the assignment, including Title 201 (Expenses) and Title 203 (Inclement Weather Practices). Title 300 Apprentices assigned to a Title 200 headquarters will continue to be paid at the Title 300 wage rate and will continue to fall under the Title 300 working conditions.
3. Apprentices will assume the schedule of the temporary headquarters or job location they are assigned. Scheduling of assignments shall not cause loss of any regular hours.
4. The specific training task and duration will be identified in writing and communicated to the Apprentice and Union Business Representative at least two weeks prior to the assignment. The Joint Apprenticeship & Training Committee will also be notified of all assignments and will be responsible for monitoring and tracking these assignments.
5. Any dispute regarding these assignments will be subject to the grievance procedure (Title 102) with the option of expedited referral to the JATC for a recommendation for settlement.

- 6. Violation of the provisions contained in the letter agreement will be cause for canceling the agreement.
- 7. Either party may cancel this agreement by providing 30 days written notice.

If you are in accord with the foregoing and agree thereto, please so indicate in the space provided below and return one executed copy of this letter to the Company.

Very truly yours,

PACIFIC GAS AND ELECTRIC COMPANY

By: s/Rick R. Doering  
Rick R. Doering, Manager and  
Chief Negotiator

The Union is in accord with the foregoing and it agrees thereto as of the date hereof.

LOCAL UNION NO. 1245, INTERNATIONAL  
BROTHERHOOD OF ELECTRICAL WORKERS

April 3, 2000

By: s/Jack McNally  
Jack McNally  
Business Manager



Note: The Industrial Skills Test (IST) has replaced the Arithmetic Computation Test (ACT) (Letter Agreement 10-13)



# **LETTER AGREEMENT NO. R1-01-38-PGE**

**IBEW**



PACIFIC GAS AND ELECTRIC COMPANY  
INDUSTRIAL RELATIONS DEPARTMENT  
2850 SHADELANDS DRIVE, SUITE 100  
WALNUT CREEK, CALIFORNIA 94598  
(925) 974-4104

INTERNATIONAL BROTHERHOOD OF  
ELECTRICAL WORKERS, AFL-CIO  
LOCAL UNION 1245, I.B.E.W.  
P.O. BOX 4790  
WALNUT CREEK, CALIFORNIA 94596  
925-933-6060

---

STEPHEN A. RAYBURN, DIRECTOR  
AND CHIEF NEGOTIATOR

PERRY ZIMMERMAN, BUSINESS MANAGER

---

August 20, 2001

Local Union No. 1245  
International Brotherhood of  
Electrical Workers, AFL-CIO  
P.O.Box 4790  
Walnut Creek, CA 94598

Attention: Mr. Perry Zimmerman, Business Manager

Dear Mr. Zimmerman:

A Joint Company-Union Sub-Committee has reviewed existing language in Letter of Agreement 84-40 and recommended that the training requirements for Station Mechanics desiring to become Substation Electricians be revised.

The Sub-committee, established through the Joint Apprenticeship and Training Committee, recommends that Letter Agreement 84-40, Item III be revised as follows:

- III. *Reclassification to Substation Electrician is initiated by the Station Mechanic submitting a written request through the First-Line Supervisor for the Superintendent's approval. The Station Mechanic must have been at the top step mechanic for two years and passed the ~~Arithmetic Computation Test (ACT)~~ Industrial Skills Test (IST), Letter Agreement 10-13. Providing the request is approved, the Station Mechanic shall complete the following performance-based training modules and wage progression test (WPT) modules from the Substation Apprentice Electrician training program. All modules must be completed in accordance with the Substation Apprentice Electrician guidelines within two years. All modules shall be completed before reclassification is final or payment of the Substation Electrician wage rate.*

If you are in accord with the foregoing and agree thereto, please so indicate in the space provided below and return one executed copy of this letter to the Company.

Very truly yours,

PACIFIC GAS & ELECTRIC COMPANY

By: s/Stephen A. Rayburn  
Stephen A. Rayburn  
Director and Chief Negotiator

The Union is in accord with the foregoing and agrees thereto as of the date hereof.

LOCAL UNION NO. 1245, INTERNATIONAL  
BROTHERHOOD OF ELECTRICAL WORKERS, AFL-CIO

September 20, 2001

By: s/Perry Zimmerman  
Perry Zimmerman

## Step 1 Training & WPT Modules

AE1-1	Basic Concepts, Electrical Quantities and Units
AE1-2	Basic Circuits, Laws and Measurements
AE1-3	Circuit Components
AE1-4	Multiple-Load Circuits
AE1-5	Analog and Digital Multimeters
AE1-6	Megger Operation
AE1-15	Power Extension Cords
AE1-20	Oil Sampling
AE1-21	GE Oil Dielectric Test (ASTM D-877)
AE1-22	Foster Oil Dielectric Test (ASTM D-1816)
AE1-23	Oil Filtering
AE1-30	Dew Point Meter Assembly and Use
WPT1-3	Dew Point Test a Nitrogen Bottle

---



# Step 1 Map

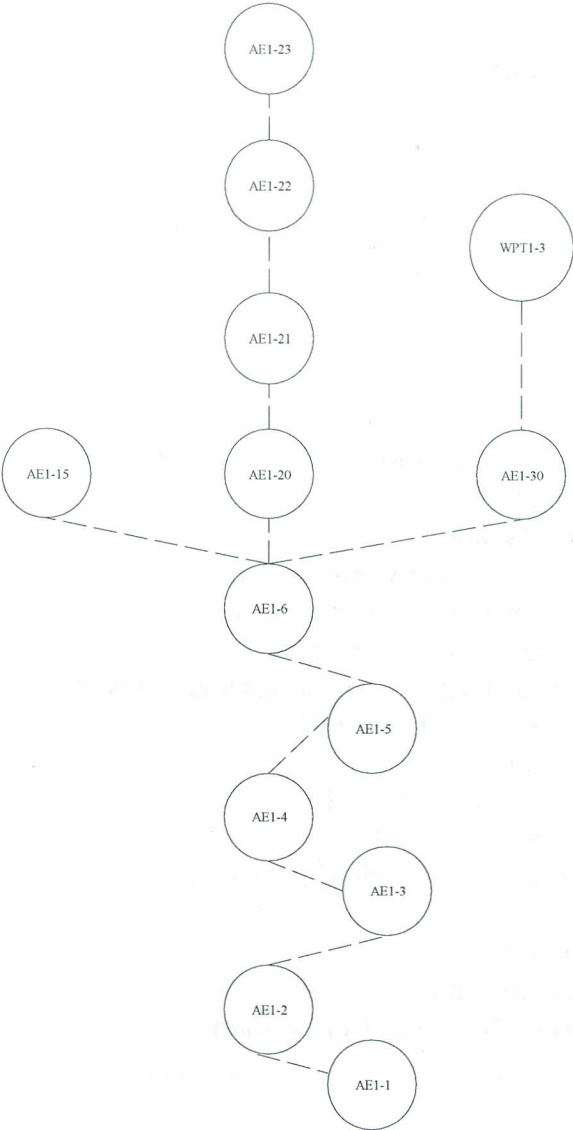

# Step 1 Map

## Step 2 Training & WPT Modules

AE2-1	Magnetism and Electromagnetism
AE2-2	Alternating Current and Voltage
AE2-3	Power in AC Circuits
AE2-4	Capacitance
AE2-5	Inductance
AE2-6	Transformers
AE2-7	Use a AC Clamp-on Ammeter
AE2-8	Use a Phase Sequence Indicator
AE2-9	Electrical Devices
AE2-10	Electrical Symbols
AE2-11	Wire Numbering System
AE2-12*	Schematic Drawing Interpretation
AE2-13*	Wiring From Schematics
AE2-14*	Electrical Troubleshooting
AE2-15	Substation Power Transformer Construction
AE2-16	Substation Power Transformer Connections
AE2-17	Substation Power Transformer Nameplate
AE2-18	Substation Power Transformer Accessories and Support Equipment
AE2-19	Transformer Insulation Resistance Test
AE2-20	Perform a DGA Sample
AE2-21	Operate a Transformer Turns Ratio Test Set
AE2-22	Perform a Transformer Polarity Test
AE2-23	Perform a Transformer Turns Ratio (TTR) Test
WPT2-1*	Wiring from Schematics
WPT2-2*	Schematic Interpretation and Troubleshooting
WPT2-3	TTR Test Transformer No-Load Tap Positions

---

## Step 2 Map

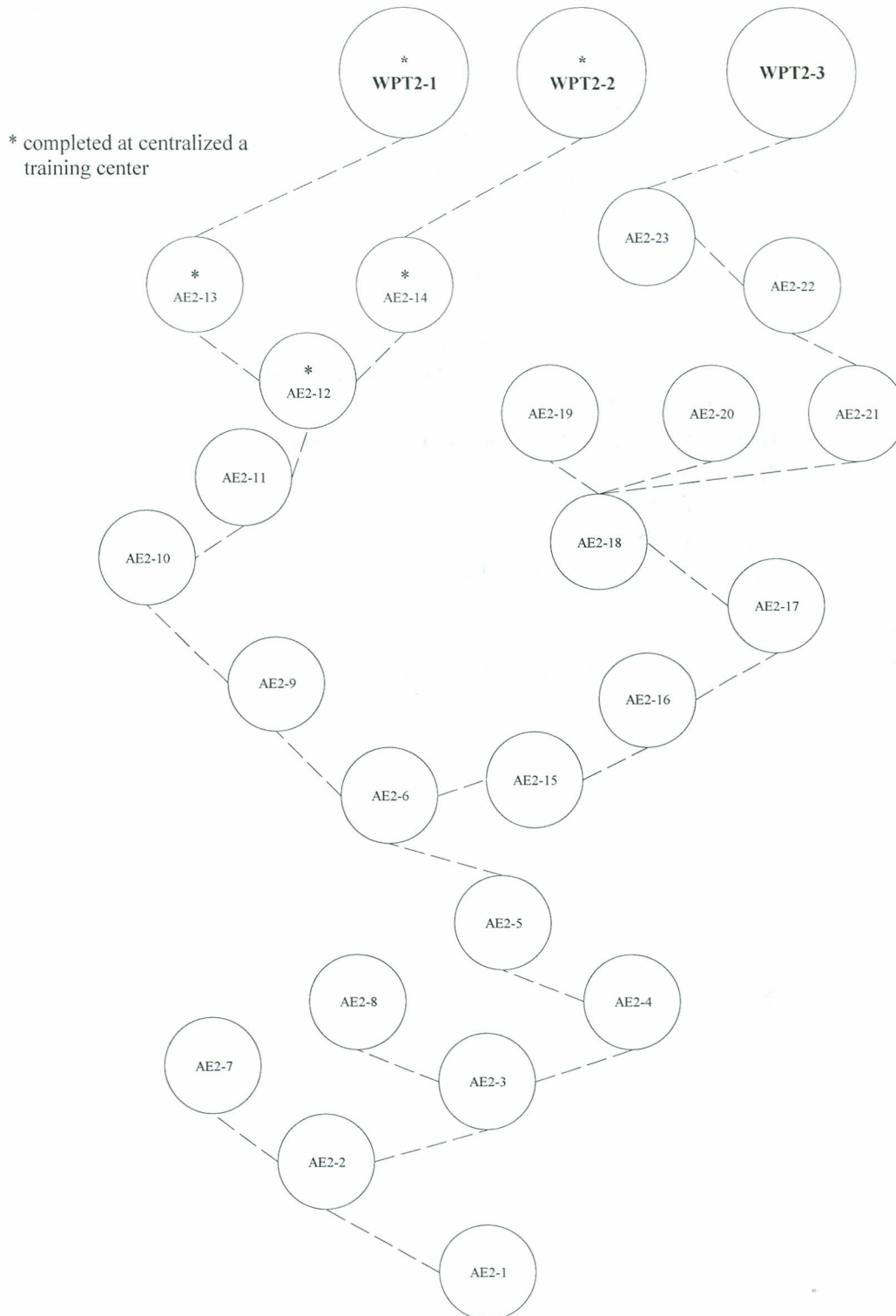



## Step 3 Training & WPT Modules

AE3-8	Diodes
AE3-9	DC Power Supplies
AE3-10	Transducers
AE3-11	Printed Circuit Board Construction and Repair
AE3-12	Battery Purpose, Types and Safety
AE3-13	Battery Charger Purpose and Operation
AE3-14	Battery Installation and Replacement
AE3-15	Battery Monthly Maintenance
AE3-16	Battery Quarterly Maintenance
AE3-17	Cell Replacement
AE3-18	Overview of Power Circuit Breakers
AE3-19	Overview of Power Circuit Breaker Mechanisms
AE3-20	Power Circuit Breakers Lubricants
AE3-21	Overview Power Circuit Breaker Diagnostics
AE3-22	Micro-Ohm Testing
AE3-23	Megger Testing
AE3-24	Breaker Time Analysis
AE3-25	Highpot Testing Vacuum Bottles
WPT3-1	Battery Maintenance
WPT3-2	Power Circuit Breaker Diagnostics

---

# Step 3 Map

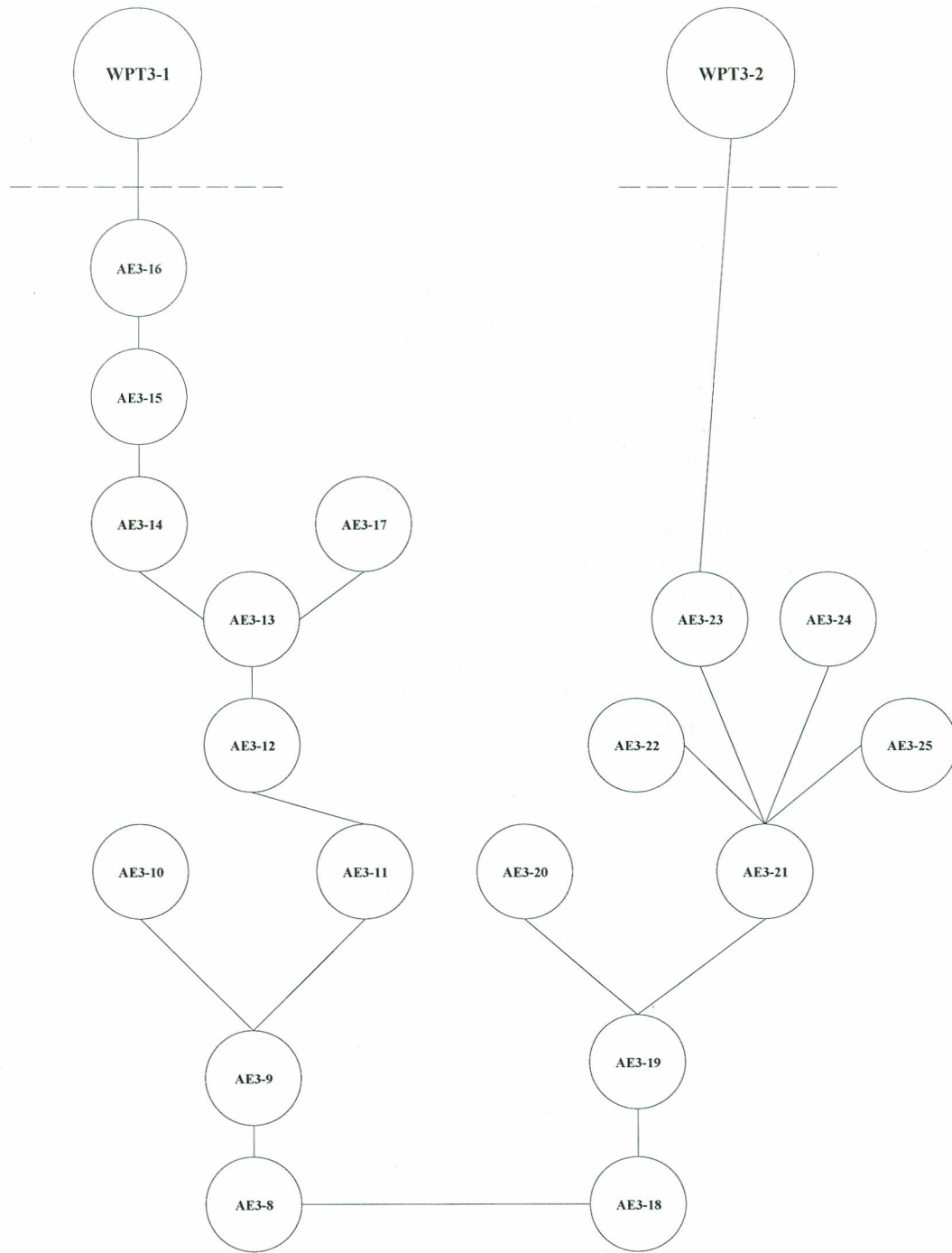

## Steps 4 & 5 Training & WPT Modules

AE4-3	Circuit Switcher Inspection & Diagnostic Tests
AE4-4	Energized Switchboard Procedures
AE4-7	Computer Basics
AE4-8	Voltage Regulation Principles
AE4-9,	Load Tap Changer Principles
AE4-10	Types of LTC Construction
AE4-11	LTC Operation
AE5-1	Potential Devices Purpose and Operation
AE5-2	Current Transformer Purpose and Operation
AE5-3	Current Transformer Testing
AE5-4,	Test Supply Set-ups and Use
AE5-5	Metering Purpose and Operation
AE5-6	Volt Meter Calibration
AE5-7	Amp Meter Calibration
AE5-8	Relay Purpose and Operation
AE5-9	Reclosing Relay Testing
AE5-10	Auxiliary Relay Testing
AE5-11	Overcurrent Relay Testing
WPT4-2	LTC Construction and Operation
WPT5-1	Amp / Volt Meter Calibration
WPT5-2	Overcurrent Relay Testing

---



# Steps 4 & 5 Map

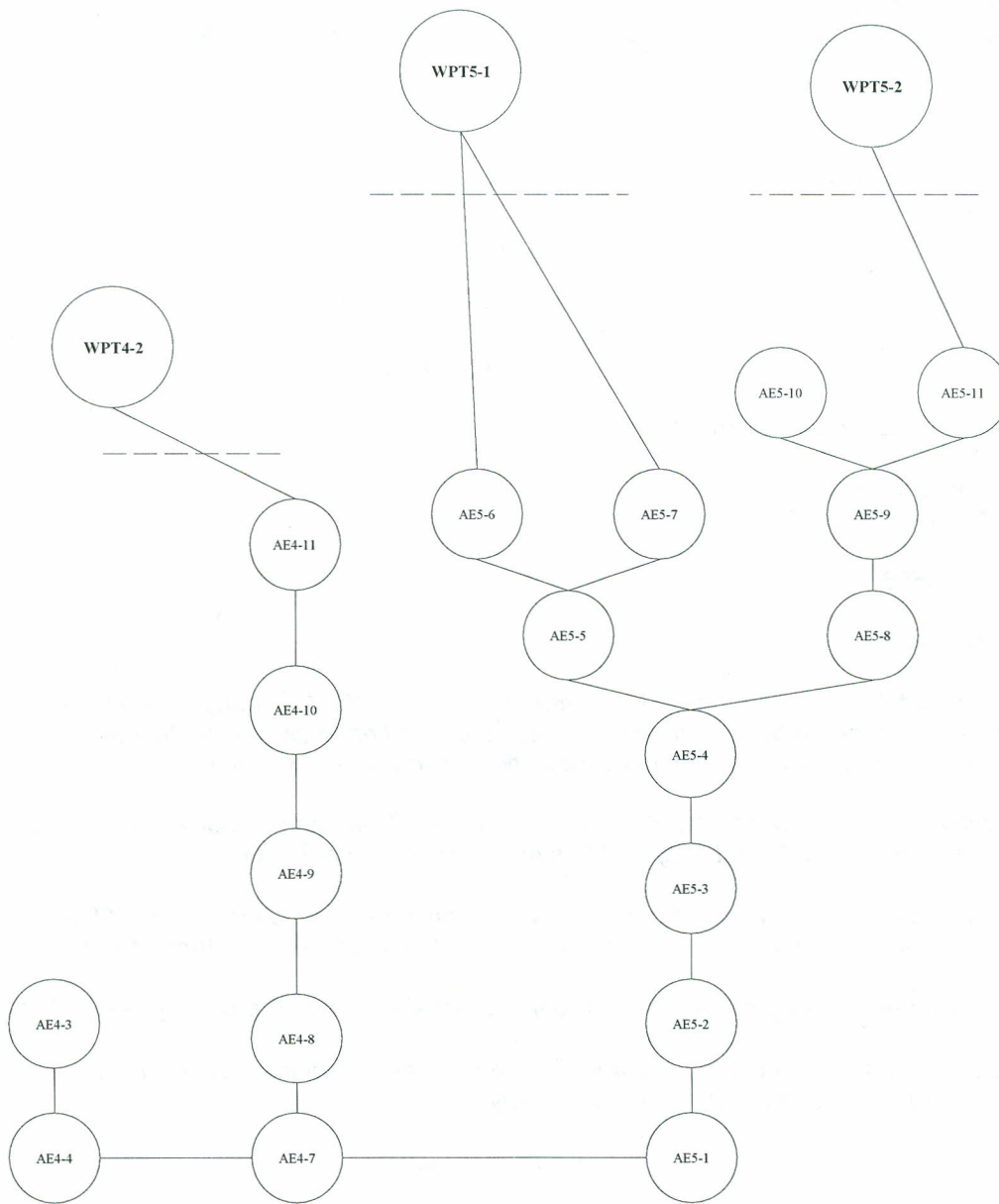



**Pacific Gas and  
Electric Company.**

# LETTER AGREEMENT NO. R1-04-11-PGE

**IBEW**



PACIFIC GAS AND ELECTRIC COMPANY  
INDUSTRIAL RELATIONS DEPARTMENT  
2850 SHADELANDS DRIVE, SUITE 100  
WALNUT CREEK, CALIFORNIA 94598  
(925) 974-4104

INTERNATIONAL BROTHERHOOD OF  
ELECTRICAL WORKERS, AFL-CIO  
LOCAL UNION 1245, I.B.E.W.  
P.O. BOX 2547  
VACAVILLE, CALIFORNIA 95696  
(707) 452-2700

STEPHEN RAYBURN  
DIRECTOR AND CHIEF NEGOTIATOR

PERRY ZIMMERMAN  
BUSINESS MANAGER

November 18, 2004

*Mr. Perry Zimmerman, Business Manager  
Local Union No. 1245  
International Brotherhood of  
Electrical Workers, AFL-CIO  
P.O. Box 2547  
Vacaville, CA 95696*

*Dear Mr. Zimmerman:*

*Item 2(g) of the October 27, 1999 Cover Letter from the Union to the Company following the 1999 General Negotiations required the parties to establish an interim committee to determine the need for training, certification and ongoing re-certification of classifications involved with switching.*

*The classifications identified were Troubleman, Transmission Troubleman, Electrician (Title 200 and 300), Electrical Technician (Title 200 and 300) and System Operator classifications.*

*The Company and Union met on a number of occasions since the ratification of the 1999 settlement package. The Company, as a result of those meetings, is proposing the attached "Switchman Certification Program."*

*Either party may cancel this agreement by providing 90-days' written notice of cancellation to the other party.*

*If you are in accord with the foregoing and agree thereto, please so indicate in the space provided below and return one executed copy of this letter to the Company.*

*Yours very truly,*

PACIFIC GAS AND ELECTRIC COMPANY

By: s/Stephen A. Rayburn  
Stephen A. Rayburn  
Director and Chief Negotiator

*The Union is in accord with the foregoing and it agrees thereto as of the date hereof.*

LOCAL UNION NO. 1245, INTERNATIONAL BROTHERHOOD OF ELECTRICAL WORKERS, AFL-CIO

January 6, 2005

By: s/Perry Zimmerman  
Perry Zimmerman  
Business Manager

## **GUIDELINES FOR THE SWITCHMAN CERTIFICATION PROGRAM**

### **Switchman**

*Employees in classifications who are currently recognized as qualified switchmen who request training will receive training in their assigned service area as needed. All switchmen in a given area will receive training as needed to perform their work. All switchmen in an area will not necessarily be trained at the same level.*

*New switchmen will receive the same training as the currently qualified switchmen – for their position (same intention as above).*

### **Current Switchman**

*Employees in classifications who are currently recognized as qualified switchmen will be certified for switching they are currently performing in their geographic area as of the date of this agreement.*

*Current switchmen who require training on a specified type of switching will be trained in a timely manner. Company would not prevent employees from requesting training and will grant such training if there is a business need to develop switchmen.*

*If a current switchman relocates, the switchman will be trained for the new geographic area as needed.*

### **Joint Apprenticeship Training Committee**

*The JATC will be responsible to develop and maintain the training program to qualify and certify switchmen.*





**Pacific Gas and  
Electric Company**

# LETTER AGREEMENT NO. 07-43-PGE

**IBEW**



PACIFIC GAS AND ELECTRIC COMPANY  
LABOR RELATIONS DEPARTMENT  
2850 SHADELANDS DRIVE, SUITE 100  
WALNUT CREEK, CALIFORNIA 94598  
(925) 974-4104

INTERNATIONAL BROTHERHOOD OF  
ELECTRICAL WORKERS, AFL-CIO  
LOCAL UNION 1245, I.B.E.W.  
P.O. BOX 2547  
VACAVILLE, CALIFORNIA 95696  
(707) 452-2700

STEPHEN RAYBURN  
DIRECTOR AND CHIEF NEGOTIATOR

TOM DALZELL  
BUSINESS MANAGER

August 16, 2007

Mr. Tom Dalzell, Business Manager  
Local Union No. 1245  
International Brotherhood of  
Electrical Workers, AFL-CIO  
P.O. Box 2547  
Vacaville, CA 95696

Dear Mr. Dalzell:

In Letter of Agreement 05-28 the parties recommended and approved the Apprentice Electrical Technician training program and two-part qualification examination. The qualification examination included Part A which was required for entrance into the classification and Part B which the employee was expected to successfully complete within 6 months of placement. Since that time, a subcommittee commissioned by the Joint Apprenticeship Training Committee, developed a revised recommendation that test Part A is now the entrance exam and test Part B is the first step wage progression test. Attached is the revised test procedure process and Study Guide. This proposal cancels and supersedes LA 05-28.

If you are in accord with the foregoing and agree thereto, please so indicate in the space provided below and return one executed copy of this letter to the Company.

Very truly yours,

PACIFIC GAS & ELECTRIC COMPANY

By: s/Stephen A. Rayburn  
Stephen A. Rayburn  
Director and Chief Negotiator

The Union is in accord with the foregoing and agrees thereto as of the date hereof.

LOCAL UNION NO. 1245, INTERNATIONAL  
BROTHERHOOD OF ELECTRICAL WORKERS, AFL-CIO

November 29, 2007

By: s/Tom Dalzell  
Tom Dalzell  
Business Manager

**Apprentice Electrical Technician Testing Flowchart**

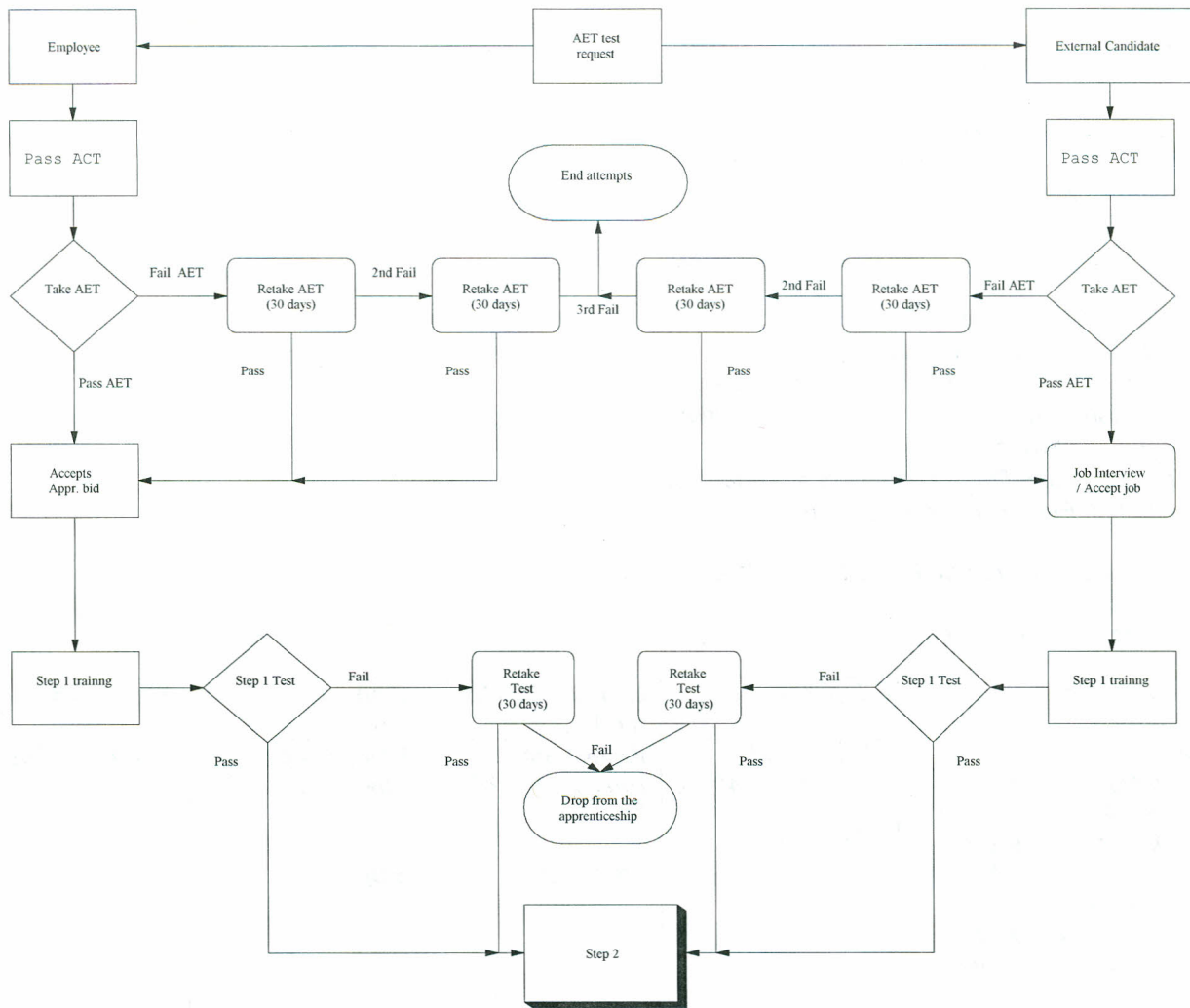

## Apprentice Electrical Technician Test

### AET Test:

#### AET Entrance Examination:

- *Electrical Theory* = 19 questions
- *Electronics* = 8 questions
- *Power and Current Transformers* = 9 questions
- *Electrical Drawings* = 4 questions

*Total = 40 questions / three hours to complete*

#### Step 1 Wage Progression Test:

- *Electrical Theory* = 6 questions
- *Substation Power Transformers* = 5 questions
- *Substation Current Transformers* = 5 questions
- *Substation Relays* = 9 questions
- *Wire Codes and Device Numbers* = 5 questions
- *Substation Electrical Drawings* = 10 questions

*Total = 40 questions / three hours to complete*

### Apprenticeship Timeline:

Step 1 (0 – 6 mo.)	Step 2 (7 – 12 mo.)	Step 3 (13 – 18 mo.)	Step 4 (19 – 24 mo.)	Step 5 (25 – 30 mo.)
<i>Training:</i> 1. <i>Introduction to Schematics – 40 hr.</i> 2. <i>Basic Relays and Phasors – 40 hr.</i> 3. <i>Substation Schematics and Automation – 24 hr</i>  <i>Step 1 OJT</i> <i>Step1 WPT</i>	<i>Relays and Phasors I – 40 hr.</i>  <i>Step 2 OJT</i>	<i>Relays and Phasors II – 80 hr.</i>  <i>Step 3 OJT</i>	<i>Relays and Phasors III – 80 hr.</i>  <i>Step 4 OJT</i>	<i>Rounding Out</i>



**Note: The Industrial Skills Test (IST) has replaced the Arithmetic Computation Test (ACT) (Letter Agreement 10-13).**

05/30/2006

**STUDY GUIDE  
FOR  
APPRENTICE ELECTRICAL TECHNICIAN (AET)  
QUALIFICATION TEST**

**About the Job**

*This job is one of the more demanding and prestigious positions within the Transmission / Substation Maintenance and Construction (TS M&C) and Hydro organizations. Continuous self-improvement and motivation are essential to stay abreast of the latest technology. Electrical Technicians work in high voltage environments that would be extremely hazardous to an untrained person. They are often called upon to work alone and without immediate supervision. Their work has a direct impact on the electric system reliability as well as employee and public safety. This work must be performed competently or else serious consequences can occur.*

*During the training program the Apprentice Electrical Technician is expected to learn and become proficient in the installation, maintenance, and operation of the following:*

- *High voltage power transformer banks*
- *High voltage power circuit breakers*
- *Current and potential transformer banks*
- *Transmission and distribution relays (microprocessor and electro-mechanical)*
- *Substation and electric utility protection systems*
- *Station automation and supervisory control and data acquisition (SCADA) systems*

**About the Test**

*The Apprentice Electrical Technician (AET) test consists of forty questions with a maximum time limit of three hours. This is a closed book test and calculators are allowed. AET test contains questions on the following:*

- *electrical theory*
- *electronics theory*
- *power and current transformers*
- *electrical drawings*

**Note:** *The Arithmetic Computation Test (ACT) must be successfully passed before taking the Apprentice Electrical Technician (AET) test.*

---

*Continued on next page*

## **Test Administration**

Within seven calendar days after taking the test, you will receive an e-mail or letter from Human Resources with your test results.

## Reference Materials

Most high school, junior college, or electrical apprenticeship course materials and textbooks on the topics described on the previous page should be sufficient.

## Sample Questions

Attachment 1 contains sample questions for the person to have some idea of what to expect. It, by no means, is a complete test and is only a tool for the person to determine how much preparation is needed.

## **AET Test Question Details**

### 1. *Electrical Theory - 19 questions*

- a. *Properties of DC and AC voltage, current, and power*
- b. *The AC sine wave*
- c. *AC voltage and current polarities*
- d. *AC conversions of rms, peak, and peak-to-peak voltages*
- e. *Math prefixes and symbols, such as mega, kilo, milli, and micro*
- f. *Convert cycles to seconds or visa versa*
- g. *Electrical units of measurement, such as resistance measured in units of ohms*
- h. *Ohm's law, Kirchhoff's current law, and Kirchhoff's voltage law*
- i. *Motor efficiency*
- j. *Sizing resistors for electrical circuits*
- k. *Series and parallel circuit operation*
- l. *Open or short circuit symptoms*
- m. *Effects caused by inductance and capacitance*
- n. *Phase displacement between AC voltage and current in inductive or capacitive circuit*
- o. *True power (W), apparent power (VA), reactive power (VAR), and power factor (%)*
- p. *Voltage and current calculations for either a wye or delta system*
- q. *Phase matching (phasing) of three-phase circuits*

---

*Continued on next page*

## **AET Test Question Details, continued**

### **2. Electronics - 8 questions**

- a. *The properties and operating principle of a diode*
- b. *Operational tests for a diode*
- c. *Half and full wave rectification circuit connections and operation*
- d. *Diode ratings and replacement values*
- e. *Rectifier filter construction and operation*
- f. *Soldering*
- g. *Basic logic gates symbols and operation, including the exclusive OR gate*

### **3. Power and Current Transformers - 9 questions**

- a. *Transformer theory and operation*
- b. *Transformer operating losses (hysteresis, eddy currents, and copper losses)*
- c. *Single-line symbols for three-phase transformer banks*
- d. *Three-phase transformer bank power, primary current, and secondary current calculations using nameplate values*
- e. *Transformer primary and secondary connections (internal and external)*
- f. *Transformer polarity and insulation tests*
- g. *Current transformer (CT) theory and operation*
- h. *Multi-ratio (tapped) CT's*
- i. *Safety precautions working with CT's*
- j. *Wye system operation with connected meters and relays*
- k. *CT ratings and classifications*
- l. *CT burden*
- m. *Polarity markings*

### **4. Electrical Drawings - 4 questions**

- a. *Clapper or plunger relays with associated contacts*
- b. *Schematic diagram interpretation*

**Attachment 1**

Sample Questions

1. In the spaces provided, write the following conversions:

- a.  $10,050 \Omega =$  \_\_\_\_\_  $k\Omega$
- b.  $12.47 kV =$  \_\_\_\_\_  $V$
- c.  $0.123 A =$  \_\_\_\_\_  $mA$
- d.  $10.6 Mw =$  \_\_\_\_\_  $w$

2. Circle the correct statement that describes what happens to a circuit with 3 resistors connected in parallel when one of the resistors is open-circuited.

- a. The circuit resistance increases.
- b. The circuit current increases.
- c. The voltage across each of the two remaining resistors increases.
- d. The amount of power consumed in the circuit remains the same.

3. Circle the correct statement that describes the operation of diodes.

- a. Diodes allow current to flow when the anode is negative in relation to the cathode.
- b. Diodes allow current to flow when the anode is positive in relation to the cathode.
- c. Diodes are only used in dc systems.
- d. Never use a diode to rectify ac.

4. Calculate the turns-ratio for a power transformer with a nameplate voltage rating of 34.655 kV to 11.95 kV. Write your answer in the space provided.

Turns-ratio = \_\_\_\_\_:1

---

Continued on next page



**Sample Questions, continued**

5. Shown below is a current transformer with the number of turns between taps. In the space provided, write the calculated voltage for taps X1 to X3 when 200 V is applied to the full secondary winding (X1 to X5).

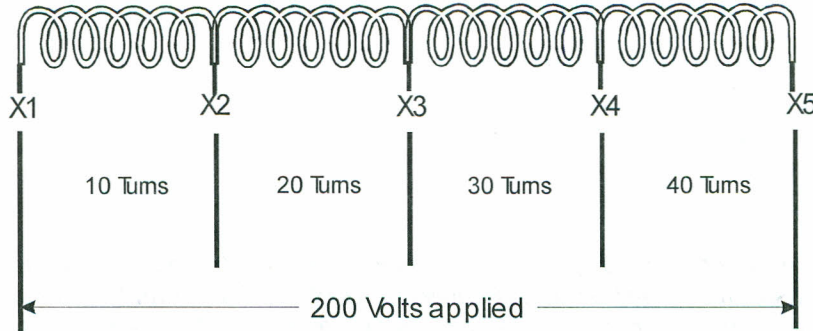

X1 to X3 = \_\_\_\_\_ Volts

6. Analyze the circuit below. Assume that all switches are open initially and then Sw. #1 is closed. Circle the correct statement.
- Lamp # 1 only is on.
  - Lamp #2 only is on.
  - Lamps #1, #2 and #3 are on.
  - Lamps #2 and #3 are on.
  - Lamp #1 and #3 are on.

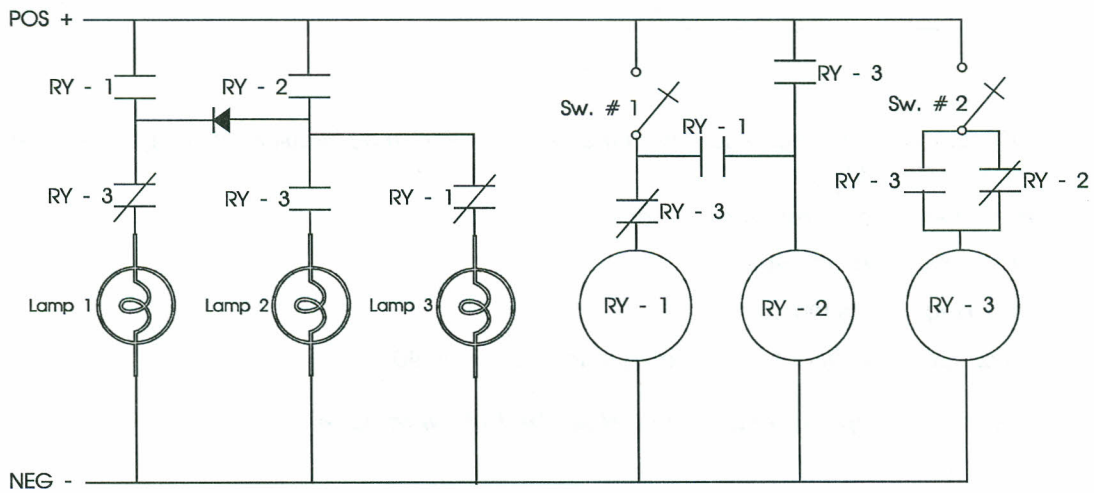

Continued on next page

**Sample Questions, continued**

7. During a saturation test of a 1500/5 multi-ratio CT, 400 volts is applied to the X1 to X4 tap. The X1 to X4 tap is the 1200/5 ratio. What is the expected voltage across the X1 to X5 tap? Circle the correct answer below.

- a. 500 V
- b. 400 V
- c. 320 V
- d. 240 V maximum
- e. 0 V

8. A phase-to-phase secondary ratio test is being conducted on a wye connected set of current transformers. Test current is applied through both the A and B-phase secondary leads. Circle the statement below where the secondary ratio current is read.

- a. A-phase ammeter, A-phase relay, and the Ground relay.
- b. A and B-phase ammeters, A and B-phase relays, and the Ground relay.
- c. A and B-phase ammeters and A and B-phase relays.
- d. B-phase ammeter, B-phase relay, and the Ground relay.
- e. C-phase ammeter, C-phase relay, and the Ground relay.

9. Write in the space provided the calculated power consumed in a dc circuit that has a current of 154 amperes and a circuit resistance of 25 ohms.

Power = \_\_\_\_\_ W

10. Circle the correct statement from the list below for an ac circuit containing resistance, and capacitive reactance,

- a. The voltage and current are in-phase.
- b. The current leads the voltage.
- c. The voltage leads the current.
- d. The phase angle between the voltage and current is 90°.

**Answers to sample questions listed on the following page.**

**Sample Questions Answers**

1. a.  $10.05\text{ k}\Omega$ , b.  $12,470\text{ V}$ , c.  $123\text{ mA}$ , d.  $10,600,0000\text{ w}$
2. a. *The circuit resistance increases.*
3. b. *Diodes allow current to flow when the anode is positive in relation to the cathode.*
4. *Turns-ratio = 2.9:1*
5. *X1 to X3 = 60 Volts*
6. a. *Lamp # 1 only is on*
7. a.  $500\text{ V}$
8. c. *A and B-phase ammeters, A and B-phase relays.*
9.  $592.9\text{ kW}$
10. b. *The current leads the voltage*

*Note: Attachments 2, 3 and 4 are not currently being used but can be found with the original letter agreement.*



**Pacific Gas and  
Electric Company.**

# LETTER AGREEMENT NO. 08-37-PGE

**IBEW**



PACIFIC GAS AND ELECTRIC COMPANY  
LABOR RELATIONS DEPARTMENT  
MAIL CODE N2Z  
P. O. BOX 770000  
SAN FRANCISCO, CALIFORNIA 94177  
(415) 973-4310

INTERNATIONAL BROTHERHOOD OF  
ELECTRICAL WORKERS, AFL-CIO  
LOCAL UNION 1245, I.B.E.W.  
P.O. BOX 2547  
VACAVILLE, CALIFORNIA 95696  
(707) 452-2700

---

STEPHEN A. RAYBURN,  
DIRECTOR AND CHIEF NEGOTIATOR

---

TOM DALZELL,  
BUSINESS MANAGER

---

November 26, 2008

Mr. Tom Dalzell, Business Manager  
Local Union No. 1245  
International Brotherhood of  
Electrical Workers, AFL-CIO  
P.O. Box 2547  
Vacaville, CA 95696

Dear Mr. Dalzell:

*On August 20, 2008 the ISTS Labor Management Committee discussed the benefits of expanding the use of Title 200 employees within ISTS working on projects with Title 300 ISTS employees. As a result, the parties agreed that this Letter Agreement cancels and supersedes L/A 00-59-PGE, the prior ISTS co-mingling agreement.*

*The parties agreed that ISTS assignments to Title 300 General Construction employees and Title 200 Maintenance employees should remain separate and distinct. However, on an exception basis, the following may be applied:*

1. *On an exception basis, Title 200 employees may be loaned to General Construction and vice versa. The Title 200 and 300 crews shall normally remain distinct, but may work side-by-side on the same project or job. Company shall keep Union informed of the status of these projects or jobs during quarterly Labor Management meetings or other appropriate communications.*
2. *Further, employees may be intermingled on the same crew, job or project where a need exists for training, additional staffing, or specialized assistance. When the need for training, additional staffing, or specialized assistance has concluded, the intermingling will be discontinued. Title 200 employees would continue to work under Title 200 provisions. Title 300 employees would continue to observe Title 300 provisions.*
3. *It is not intended that the placement of an Apprentice within a work group for training opportunities result in the employee performing production work.*
4. *Clerical Support may come from Title 200, Title 300, or Clerical employees.*



5. On occasion, T200 employees may be provided opportunities to take rotational assignments into management positions. During the rotation, temporary bargaining unit vacancies may need to be filled. If the 205.3 process does not result in the temporary vacancies being filled, then T300 employees may be loaned to a T200 work group for the purpose of filling those vacancies created by T200 employees on rotation. These T300 rotational assignments will be limited to 90 days with one (1) 90 day extension possible if mutually agreed to at the local level by Company and Union. Such temporary relief is not to exceed 180 days. Relief behind an absent employee may continue until the absent employee's return. Title 300 employees would continue to observe Title 300 provisions while working with the T200 group.
6. Sharing of equipment and tools and common assembly points and work locations is permissible.
7. Joint training, safety, and local Labor Management Committees are recommended.
8. This agreement does not modify the provisions of Sections 205, 206, 208, 212, 305, 306, and 308 of the Agreement. For purposes of equitable distribution of pre-arranged overtime pursuant to Section 208.16, Pre-Review Committee Decision 1118, et al., shall be applicable.

*Either party may cancel this agreement by providing 60 days written notice of cancellation.*

*If you are in accord with the foregoing and agree thereto, please so indicate in the space provided below and return one executed copy of this letter to the Company.*

*Very truly yours,*

*PACIFIC GAS & ELECTRIC COMPANY*

By: s/Stephen A. Rayburn  
Stephen A. Rayburn  
Director and Chief Negotiator

*The Union is in accord with the foregoing and agrees thereto as of the date hereof.*

*LOCAL UNION NO. 1245, INTERNATIONAL  
BROTHERHOOD OF ELECTRICAL WORKERS,  
AFL-CIO*

December 18, 2008

By: s/Tom Dalzell  
Tom Dalzell  
Business Manager

*Note: The Industrial Skills Test (IST) has replaced the Arithmetic Computation Test (ACT) (Letter Agreement 10-13).*



**Pacific Gas and  
Electric Company™**

# **LETTER AGREEMENT NO. 09-31-PGE**

**IBEW**



PACIFIC GAS AND ELECTRIC COMPANY  
LABOR RELATIONS AND HUMAN RESOURCES  
DEPARTMENT  
MAIL CODE N2Z  
P. O. BOX 770000  
SAN FRANCISCO, CA 94177  
(415) 973-4310

INTERNATIONAL BROTHERHOOD OF  
ELECTRICAL WORKERS, AFL-CIO  
LOCAL UNION 1245, I.B.E.W.  
P.O. BOX 2547  
VACAVILLE, CALIFORNIA 95696  
(707) 452-2700

---

STEPHEN A. RAYBURN  
DIRECTOR AND CHIEF NEGOTIATOR

---

TOM DALZELL  
BUSINESS MANAGER

July 20, 2009

*Mr. Tom Dalzell, Business Manager  
Local Union No. 1245  
International Brotherhood of  
Electrical Workers, AFL-CIO  
P.O. Box 2547  
Vacaville, CA 95696*

*Dear Mr. Dalzell:*

*This Letter Agreement cancels and supersedes Letter Agreement 79-83, signed July 20, 1979.*

*In 2008, a joint Ad Hoc Committee was established to revise the Apprentice Telecommunications Technician entrance examination (CTT). On July 10, 2009 the recommendations of the Ad Hoc Committee, which are enclosed, were submitted to the Joint Apprenticeship and Training Committee (JATC) for adoption. The Ad Hoc Committee developed two tests, Test 1 and Test 2. The passing of this test is a pre-requisite for entry to the (2408) Apprentice Telecommunications Technician and (2391) Apprentice Communication Technician classifications. Additionally, satisfactory completion of the Physical Test Battery (PTB) and the Arithmetic Computation Test (ACT) are pre-requisites for these apprenticeships.*

*JATC adopted the recommendations of the Ad Hoc Committee, with the understanding that until this Letter Agreement is executed, the Company may administer the new test as a pilot. Employees that fail the new test may opt to take the current Apprentice Telecommunications Technician entrance exam, if eligible.*

*The passing score of the new exam will be 72.2% or 26 correct answers out of 36 questions. The retesting schedule remains unchanged:*

- 2<sup>nd</sup> Testing – Three (3) months, or thereafter, following the date of the first testing.
- 3<sup>rd</sup> Testing – Six (6) months, or thereafter, following the date of the second testing.
- 4<sup>th</sup> Testing – Six (6) months, or thereafter, following the date of the third testing, provided that the employee is able to show satisfactory evidence that the employee has prepared himself or herself to pass the test. Failure of an employee to provide appropriate documentation as required will release the Company from any further obligation to retest or to consider the employee for future vacancies in the Apprentice Telecommunications Technician classification.

The above requirements and testing schedule will apply to all employees who are tested after the effective date of this agreement.

If you are in accord with the foregoing and enclosures and agree thereto, please so indicate in the space provided below and return one executed copy of this letter to the Company.

Yours very truly,

PACIFIC GAS AND ELECTRIC COMPANY

By: s/ Stephen Rayburn  
 Stephen A. Rayburn  
 Director and Chief Negotiator

The Union is in accord with the foregoing and enclosures, and it agrees thereto as of the date hereof.

LOCAL UNION NO. 1245, INTERNATIONAL  
 BROTHERHOOD OF ELECTRICAL WORKERS,  
 AFL-CIO

July 29, 2009

By: s/ Tom Dalzell  
 Tom Dalzell  
 Business Manager





**Pacific Gas and  
Electric Company™**

# LETTER AGREEMENT NO. 12-32-PGE

**IBEW**



PACIFIC GAS AND ELECTRIC COMPANY  
LABOR RELATIONS AND HUMAN RESOURCES  
DEPARTMENT  
MAIL CODE N2Z  
PO Box 770000  
SAN FRANCISCO, CALIFORNIA 94177  
(415) 973-4310

INTERNATIONAL BROTHERHOOD OF  
ELECTRICAL WORKERS, AFL-CIO  
LOCAL UNION 1245, I.B.E.W.  
P.O. BOX 2547  
VACAVILLE, CALIFORNIA 95696  
(707) 452-2700

STEPHEN RAYBURN  
DIRECTOR AND CHIEF NEGOTIATOR

TOM DALZELL  
BUSINESS MANAGER

January 11, 2013

Mr. Tom Dalzell, Business Manager  
Local Union No. 1245  
International Brotherhood of  
Electrical Workers, AFL-CIO  
P.O. Box 2547  
Vacaville, CA 95696

Dear Mr. Dalzell:

*This Letter Agreement reflects the agreement reached in general negotiations regarding the Commercial Driver's License Addendum (CDLA). The Company will convert the existing \$600 CDLA premium to an hourly rate for those employees covered by a CDLA letter agreement. In addition, the CDLA hourly wage rate will be extended to additional classifications covered by this agreement. This agreement cancels and supersedes Letter Agreement R1-12-08. Details of the agreement are as follows:*

1. *For Electric T&D and Gas T&D Title 200 employees only, the parties agree to update Letter Agreement 90-113 (Commercial Driver's License Addendum—CDLA) to include (1) 150% ratio of employees with Commercial Driver's License (CDL) to vehicles at the headquarters and (2) employees on a daily upgrade currently paid at \$2.50/day shall now be upgraded to the CDLA designated classification.*
2. *Incumbent employees in the Gas and Electric T&D Departments or General Construction Line or Gas Departments who promote or bid/transfer into the Title 200 Gas and Electric T&D Departments or Title 300 Line or Gas Departments in the future will be eligible for the higher CDLA wage rate if the position requires a CDL by job definition or a CDL to meet the 150% ratio or the local headquarters desires an additional CDL for operating flexibility.*
3. *Incumbent employees in the Title 200 and 300 Fleet Department shall be treated the same as above. The Company and Union will address other departments, if needed, consistent with this agreement.*
4. *In addition to the employee groups identified above, all employees with a CDL currently in physical bargaining unit classifications that require a commercial driver's license as part of the job definition, eligible or required by letter of agreement, or based upon the Company and Union's current understanding that employees utilize a commercial driver's license for the convenience of the Company, will have the \$600 premium added to the base wage rate.*
5. *Attached is a list of the impacted classifications. The Company and Union will review each classification to determine the future need for a commercial driver's license. It is not the intent of either*



party to omit classifications that utilize a commercial driver's license for the convenience of the Company, by letter of agreement or required by job definition, therefore, the parties agree to meet and discuss other classifications which may meet the criteria and were not included in the attachment.

6. There may be situations where the CDL is not required for all employees in a classification; however, due to operational need, a CDL may be required for individuals in that classification. The parties agree to handle these on a case-by-case basis via letter of agreement, where applicable.
7. Current and future Pre-apprentice Lineman will be required to maintain the CDL upon progression.
8. Effective July, 25, 2012, all new hires, bidders and transfers from outside the lines of progression to Gas and Electric T&D, General Construction Gas and Line Departments or other Departments as described herein will be required to have and maintain a CDL as part of their job duties and will not receive additional compensation. Employees must obtain a Class A permit by month 3 and a Class A driver's license within 12 months unless Company is unable to provide timely training.
9. For departments such as Fleet, new hires, bidders and transfers shall be treated the same as above. The Company and Union will address other departments if needed, consistent with this agreement.
10. Accommodation of Current Employees Without Licenses: Employees who are currently being accommodated in a position requiring a license will continue to be accommodated unless there is significant change in local operating conditions which prevent the accommodation or the employee's condition changes.
11. Future Accommodation of Employees with Suspended Licenses: Employees who currently possess a license, but have their license temporarily suspended or who are temporarily unable to drive for other reasons, will be considered for accommodation on a case by case basis taking into consideration local operating conditions and the length of the suspension or inability to drive. Accommodation decisions will be subject to the grievance procedure.
12. Employees unable to maintain CDL for a medical condition will be reviewed for accommodation on a case-by-case basis. Accommodation decisions will be subject to the grievance procedure.
13. Company shall pay all cost associated with obtaining and maintaining the CDL.
14. The Company is meeting with SAP/Payroll to determine how to include the CDL premium into the base wage rate. The Company will discuss alternatives with the Union and reach agreement on the process used. In addition to updating this agreement with additional classifications the Company and Union have reached agreement on the SAP/Payroll process to be used. The CDL pay will be included in the base wages by converting the \$600 annual amount to an hourly rate of \$0.29 effective November 1, 2012. This hourly CDL rate will be adjusted by the GWI each year and then added to an eligible employee's base wage rate. As described in the table of contents of Exhibit X, attached are CDL wage rates for 2012 - 2014. CDL pay will be included as base wages for eligible employees as identified in this agreement who properly update the Company with their Class A license information and participate in the Company's DOT Class A Random Drug testing.
15. The wage rate changes will be effective upon SAP implementation and retroactive to November 1, 2012. The parties agree to retroactively include the CDL base wage rate for retirement calculation purposes for covered employees who retire on or after July 1, 2012.

If you are in accord with the foregoing and agree thereto, please so indicate in the space provided below and return one executed copy of this letter to the Company.

Very truly yours,

PACIFIC GAS & ELECTRIC COMPANY

By: s/Stephen A. Rayburn  
Stephen A. Rayburn  
Director and Chief Negotiator

*The Union is in accord with the foregoing and agrees thereto as of the date hereof.*

LOCAL UNION NO. 1245, INTERNATIONAL  
BROTHERHOOD OF ELECTRICAL WORKERS, AFL-CIO

January 1, 2013

By: s/Tom Dalzell  
Tom Dalzell  
Business Manager



Title 200 & 300 Classifications currently holding CDL required by Job Definition, LA (93-39) or  
Title 200 Classifications eligible for CDLA Premium per LA 90-113, 92-28 (PLO) or 90-228 (Fleet).

Note: *Bolded Lines reflect T200 Classifications currently receiving CDL per LA*

	<u>SAP Job Code</u>	<u>Job Title</u>	<u>Legacy Code</u>
<b>Title 200</b>	<b>50010376</b>	<b>Apprentice Cable Splicer</b>	<b>2281</b>
<b>Title 200</b>	<b>50010155</b>	<b>Apprentice Electrician-Electric &amp; Hydro</b>	<b>0481</b>
<b>Title 200</b>	<b>50010168</b>	<b>Apprentice Fitter</b>	<b>0561</b>
<b>Title 200</b>	<b>50010245</b>	<b>Apprentice Lineman</b>	<b>1101</b>
<b>Title 200</b>	<b>50010260</b>	<b>Apprentice Lineman Transmission</b>	<b>1188</b>
<b>Title 200</b>	<b>50010375</b>	<b>Cable Splicer</b>	<b>2280</b>
Title 200	50010317	Crane Operator	1594
<b>Title 200</b>	<b>50010191</b>	<b>Electric Crew Foreman</b>	<b>0740</b>
Title 200	50010193	Electric Crew Foreman - Transmission	0746
<b>Title 200</b>	<b>50010194</b>	<b>Electric Maintenance Crew Leader</b>	<b>0750</b>
Title 200	50010242	Electric Transm & Dsbn Assistant	1096
<b>Title 200</b>	<b>50010149</b>	<b>Electrician - Electric &amp; Hydro</b>	<b>0467</b>
Title 200	50010273	Equipment Mechanic	1255
Title 200	50010276	Equipment Mechanic - DCPD	1259
Title 200	50010320	Equipment Operator - Gas	1645
Title 200	50010147	Field Clerk - Electric Transm & Dsbn	0458
<b>Title 200</b>	<b>50010161</b>	<b>Fieldperson</b>	<b>0524</b>
<b>Title 200</b>	<b>50010167</b>	<b>Fitter</b>	<b>0560</b>
<b>Title 200</b>	<b>50010169</b>	<b>Fitter – Arc</b>	<b>0562</b>
Title 200	50010186	Garage Subforeman	0730
Title 200	50010427	Gas Control Technician - CGT	2435
<b>Title 200</b>	<b>50010175</b>	<b>Gas Crew Leader Non-Welding</b>	<b>0641</b>
<b>Title 200</b>	<b>50010174</b>	<b>Gas Crew Leader Welding</b>	<b>0640</b>
<b>Title 200</b>	<b>50010283</b>	<b>Gas Mechanic</b>	<b>1300</b>
Title 200	50010322	Heavy Equipment Operator	1650
Title 200	50010144	Lead Driver	0433
<b>Title 200</b>	<b>50010244</b>	<b>Lineman</b>	<b>1100</b>
<b>Title 200</b>	<b>50010241</b>	<b>Lineman - Transmission</b>	<b>1094</b>
Title 200	50010298	Mechanic – Welder - CGT	1440
<b>Title 200</b>	<b>50010378</b>	<b>Night Cable Splicer</b>	<b>2283</b>
Title 200	50010243	Night Electric Transm & Dsbn Assistant	1098
Title 200	50010324	Transm & Dsbn Equipment Opr - Transm	1662
Title 200	50010323	Transmission & Distribution Equip Opr	1660
Title 200	50010294	Transmission Mechanic – CGT	1406
Title 200	50010148	Truck Driver Heavy - Gas	0465
<b>Title 200</b>	<b>50010380</b>	<b>Unassigned Cable Splicer</b>	<b>2286</b>
<b>Title 200</b>	<b>50010156</b>	<b>Unassigned Electrician - Elec &amp; Hydro</b>	<b>0484</b>
<b>Title 200</b>	<b>50010170</b>	<b>Unassigned Fitter</b>	<b>0563</b>
<b>Title 200</b>	<b>50010246</b>	<b>Unassigned Lineman</b>	<b>1103</b>
Title 200	50072958	Unassigned Transmission Mechanic - CGT	1414
Title 200	50010361	Unassigned Water System Repairperson	2068
<b>Title 200</b>	<b>50010188</b>	<b>Underground Constr Crew Frmn - Electric</b>	<b>0737</b>
<b>Title 200</b>	<b>50010189</b>	<b>Underground Constr Crew Frmn - Gas</b>	<b>0738</b>

	<u>SAP Job Code</u>	<u>Job Title</u>	<u>Legacy Code</u>
<b>Title 200</b>	<b>50010234</b>	<b>Underground Constr Journeyman - Elec</b>	<b>1077</b>
<b>Title 200</b>	<b>50010235</b>	<b>Underground Constr Journeyman - Gas</b>	<b>1078</b>
Title 200	50010202	Working Foreman*	0845
Title 200	50010271	Utility Equipment Mechanic – Auberry	1252
Title 200	50010272	Utility Equipment Mechanic – Helms	1253
Title 200	50010347	Utility Operator - Hydro	1824
Title 200	50010362	Water System Repairperson	2070
Title 200	50368698	Pre-apprentice Lineman	1114
Title 300	50010305	Backhoe Operator – *Gas Req after 1/1/2009	1515
Title 300	50070801	Crane Operator - Davis	1596
Title 300	50010318	Crane Operator - GC Field - Gas	1597
Title 300	50253877	Crane Operator – GC Field – Not Gas	1613
Title 300	50010140	Driller	0405
Title 300	50010277	Equipment Mechanic - GC	1260
Title 300	50010279	Field Garage Mechanic A	1270
Title 300	50010281	Field Garage Mechanic C	1276
Title 300	50010230	Field Mechanic Inspector	1006
Title 300	50010162	Fieldperson - GC - Gas	0525
Title 300	50210150	Fieldperson - Tower	0525
Title 300	50010326	Hole Digger Operator	1690
Title 300	50010231	Mechanical Inspector	1007
Title 300	50010321	Miscellaneous Equipment Operator-Gas	1646
Title 300	50253878	Miscellaneous Equipment Operator-Not Gas	1616
Title 300	50368700	Pre-apprentice Lineman - GC	1115
Title 300	50258203	Tapping Technician	0261
Title 300	50010351	Tractor Operator - Gas	1840
Title 300	50253879	Tractor Operator-Not Gas	1617

\*Per L/A 07-56 Working Foreman 0845 shall have a class A license

CDL List T200 & T300 Utilized for Company Convenience

	<u>SAP Job Code</u>	<u>Job Title</u>	<u>Legacy Code</u>
Title 200	50010360	Apprentice Water System Repairperson	2067
Title 200	50010227	Compliance Inspector	0998
Title 200	50010228	Compliance Inspector - Underground	0999
Title 200	50070742	Electrician - Switching	0494
Title 200	50202594	Engine Analyst - CGT	1422
Title 200	50010210	Garageman	0880
Title 200	50010413	Gas Control Technician – Division	2410
Title 200	50010427	Gas Control Technician – GSM	2435
Title 200	50315043	M&C Coordinator - Electric	1005
Title 200	50315042	M&C Coordinator - Gas	1004
Title 200	50315041	M&C Coordinator – Gas Transmission	1008
Title 200	50010197	Maintenance Subforeman - DCPD	0755
Title 200	50010232	Meteorological Instrumentperson	1036
Title 200	50010431	Transmission Troubleman	2535



Title 200	50010258	Traveling Machinist - Diablo Canyon	1146
Title 200	50010370	Traveling Mechanic-Rigger - DCPD	2174
Title 200	50010432	Troubleman	2540
Title 200	50010371	Unassigned Traveling Mech-Rigger - DCPD	2176
Title 200	50010112	Utility Field Clerk - Bakersfield	0242
Title 200	50010217	Utility Worker – Gas Transm & Dsbn	0930
Title 200	50010200	Water System Crew Leader	0830
Title 300	50010379	Apprentice Cable Splicer - GC	2285
Title 300	50010157	Apprentice Electrician - GC	0488
Title 300	50010248	Apprentice Lineman - GC	1107
Title 300	50010438	Apprentice Welder - GC - Gas	2628
Title 300	50253876	Backhoe Operator-Not Gas	1612
Title 300	50010377	Cable Splicer – GC	2282
Title 300	50010096	Carpenter A-Gas	0163
Title 300	50010097	Carpenter B-Gas	0164
Title 300	50253770	Carpenter A- Not Gas	1601
Title 300	50253771	Carpenter B- Not Gas	1604
Title 300	50010152	Electrician - GC	0474
Title 300	50073099	Field Garageman	0885
Title 300	50010208	Garage Working Foreman	0857
Title 300	50010173	Labor Foreman A	0630
Title 300	50010247	Lineman –GC	1106
Title 300	50010287	Station Mechanic	1337
Title 300	50010171	Street Fitter	0580
Title 300	50010179	Subforeman A - Overhead	0650
Title 300	50010180	Subforeman A - Station/Hydro	0651
Title 300	50010178	Subforeman A - Underground	0649
Title 300	50010181	Subforeman B	0653
Title 300	50010223	Utility Worker - GC	0947
Title 300	50010435	Welder - GC - Gas	2617
Title 300	50253880	Welder - GC-Not Gas	1618
Title 300	50251365	Working Foreman A - Non-Climbing	0105
Title 300	50010205	Working Foreman B - Climbing	0853
Title 300	50010206	Working Foreman C – Gas	0854
Title 300	50251368	Working Foreman B – Gas	0255
Title 300	50251366	Working Foreman A – Gas	0257
Title 300	50251367	Working Foreman B - Non-Climbing	0107
Title 300	50253775	Working Foreman C-Not Gas	1608

*Retained for Historical Purposes*

## LETTER AGREEMENT

### NO. 93-69-PGE

October 8, 1993

Pacific Gas & Electric Co.  
201 Mission Street, Fifteenth Floor  
San Francisco, CA 94105

Attention: Mr. David Bergman  
Director & Chief Negotiator

Gentlemen:

Pursuant to the provisions of Titles 305 and 306 and the understandings reached at the conclusion of negotiations for the Labor Agreement dated January 1, 1991, and the Union and Company Subcommittees' subsequent discussions, we are submitting the following proposal relative to the Lines of Progression in the General Construction Line Department as they pertain to Titles 305 and 306.

The proposed Lines of Progression are set forth on the attached General Construction Line Department Lines of Progression chart. Other letter agreements, Labor Agreement Clarifications and grievance settlements clarifying the Lines of Progression are also attached. Certain of these letter agreements and clarifications have been modified to reflect other changes that took place subsequent to the signing of the original document. Such changes are identified in each document by **bracketing [ ] deletions and boldfacing additions**. Each document is incorporated herein as though set forth in full. These Lines of Progression will be effective on execution of this letter agreement.

If you are in accord with the foregoing and agree thereto, please so indicate in the space provided below and return one executed copy of this letter to the Union.

Yours truly,

LOCAL UNION NO. 1245, INTERNATIONAL  
BROTHERHOOD OF ELECTRICAL WORKERS,  
AFL-CIO

By: s/Jack McNally  
**Jack McNally**  
Business Manager

The Company is in accord with the foregoing and agrees thereto as of the date hereof.

PACIFIC GAS AND ELECTRIC COMPANY

October 15, 1993

By: s/David J. Bergman  
**David Bergman**  
Director & Chief Negotiator

Attachment: a/s

RS:lm



*Retained for Historical Purposes*

**GENERAL CONSTRUCTION**  
**CLASSIFICATION CONSOLIDATION**  
**AND LINES OF PROGRESSION**

**Duties of Consolidated Classifications**

Adoption of this agreement will result in the elimination of several existing classifications and the consolidation of the duties of these classifications into a few newly established classifications. The parties understand and agree that the duties to be performed by the new classifications established by this agreement are limited to those duties formerly assigned to the classifications being eliminated/consolidated into a single classification and any new or additional duties specifically provided for in this agreement. For example, -the consolidated **Utility Worker** [Helper] classification may perform the duties formerly appropriately assigned to the Engineers Aid (field duties), Second Faller, Groundman, Steel Assembly Groundman, Jackhammerman, Laborer, Material Man, Pipewrapper Hand Small, and Hand Large.

**Wage Consideration**

On the effective date of this agreement, incumbent employees shall be reclassified in accordance with the attached exhibits. If an incumbent is receiving a wage rate which is more than the top of the new consolidated classification, such employee shall not have his wage rate reduced but shall continue to receive his current wage rate and future general wage increases until such time as the employee permanently leaves the classification to which he has been reclassified.

Incumbent employees who are below the top step of their current classification shall continue to receive progressive wage increases and general wage increases in accordance with the wage schedule of their current or new classification, whichever is higher until they permanently vacate the classification to which they have been reclassified.

New hires or incumbent employees promoted to or demoted to the consolidated classifications on or after the effective date of the agreement shall be paid in accordance with the new wage schedules established by this agreement.

**Bidding Rights to Region Classifications**

A task force will be established to revise Title 600, Exhibit VI to incorporate, as appropriate, the classifications being established in this agreement, in such a way as to not reduce the current bidding rights of incumbent or future General Construction employees. If such revisions are incomplete as of the effective date of this agreement, the parties shall agree to an interim procedure which does not reduce the current bidding rights of incumbent or future General Construction employees.

**Wage Differentials G.C.-Regions**

On January 1, 1991 and each year thereafter for the term of the Agreement, classifications that are comparable between General Construction and the Regions shall be adjusted to maintain a minimum 5% differential between such classifications.

Company and Union shall prepare a list -of classifications that are considered to be comparable between General Construction and the Regions. Where necessary other non-comparable General Construction

classifications shall also be adjusted annually to maintain historical relationship/separation between comparable and non-comparable GC classifications. The **Utility Worker** [Helper] shall be considered comparable to the Region (0930) **Utility Worker** [Helper]; the new classification of G. C. Fieldperson[man] shall be considered comparable to the Region (0524) Fieldperson[man]; and the new classification of Miscellaneous Equipment Operator shall be considered comparable to a combination of the Region (0465) Heavy Truck Driver and the Region (1645) Equipment Operator.

**Working Foreman B and Subforeman A**  
**- Station/Substation/Hydro Department**

In the Station/Substation/Hydro Department, the parties agree to add Subforeman A and Working Foreman B classifications in the welding line of progression and Hydro line of progression, subject to the restrictions and limitations noted on the Station/Substation/ Hydro Line of Progression Chart.

**Technology**

Attached is a list of new classifications, equipment, and job definitions. This list is intended to be inclusive of current duties appropriately assigned to the new, consolidated classification. The parties recognize that technological advances may raise questions about appropriate duties to assign to a classification in the future.

Therefore, Company and Union agree to establish a standing committee consisting of two representatives from Company and two representatives from Union to review new equipment and duties to determine the proper classification. Should such committee be unable to reach agreement on the appropriate classification to assign new equipment or duties to, the issue will be addressed pursuant to the provisions of Title 102. During the time such committee continues to discuss such issues, however, the time limits in Title 102 shall be suspended.

**0947 - UTILITY WORKER** [HELPER]

Will replace the following classifications:

- 0050 Engineer's Aid
- 0523 Second Faller
- 0910 Groundman
- 0915 Steel Assembly Groundman
- 1040 Jackhammerman
- 1080 Laborer
- 1205 Material Man
- 1970 Pipewrapper, Hand Large
- 1975 Pipewrapper, Hand Small

**Utility Worker** [Helper]: An employee whose principal duties consist of semi-skilled work while assisting a higher classified employee. **Utility Workers** [Helpers] assist in construction and maintenance and other miscellaneous semi-skilled work. With adequate training and under direction, may be required to: use hand tools, portable power tools, pavement breakers, spaders, tampers or compactors for work not requiring precision; perform pipe wrapping duties. A **Utility Worker** [Helper] in Line Department may be permitted to learn to climb on the job in training for advancement, but shall not do line work.

Pursuant to Section 306.10, Company agrees not to demote incumbent Pipewrappers, Art Atondo and Donald Cook, for reasons other than lack of work.

Office duties formerly assigned to the Engineer's Aid classification shall be reassigned to the appropriate field clerical classification.

0947 - Utility Worker [Helper]  
(as of 1/1/90)

Wage Rate  
(as of 1/1/91)



Start:	\$475.70	493.55
6 Mos:	520.75	540.30
1 Yr.:	565.70	586.95
18 Mo:	610.65	633.55
2 Yrs:	636.85	660.75

**0525 - G.C.FIELDPERSON [MAN]**

Will replace the following classifications:

- 0165 Carpenter C
- 0415 Truck Driver
- 0520 Faller
- 1450 Metalman
- 1573 Compressor Operator B
- 1643 Miscellaneous Equipment Operator B
- 1644 Miscellaneous Equipment Operator C
- 1980 Powderman

Employees in the Fieldperson[man] classification, on a voluntary basis, may perform the duties of the former Powderman classification, upon obtaining the appropriate license.

GC Fieldperson[man] wage rate (Classification Code 0525)

	(Effective 1/1/90)	(Effective 1/1/91)
Start:	\$643.80	667.95
6 Mo.:	650.60	675.00
1 Yr.:	669.55	694.70
18 Mo.:	690.30	716.20
2 Yr.:	699.80	726.05

GC FIELDPERSON[MAN] - Operates the following equipment:

- Earthworm;
- Gas/electric hoist up to 15 HP;
- Concrete Mixers 1/2 cu. yd. and under
- Concrete saws;
- Tractor, Pneumatic Tired Loader, less than 1 1/2 cu. yds. with or without scrapper;
- Compactors, self-propelled, riding such as: Arrow Hydra-Hammer/compactor, Champion Stroke Hammer, Ohawa Hydra-Hammer/tamper, R&O Hydra-Hammer/compactor, Superhammer/compactor, or equivalent; Tugger Air Hoist;
- Air compressor up to 1000 C.F.M.;
- Riding roller, self-propelled;
- Street Sweeper, self-propelled, small; Small
- Snow Cat, such as Bombadier;

- Two-axle truck of 12,000 lb. GVW or over;
- Small tiller type tractor or similar hauling unit, 30 HP and under;
- Industrial material handling truck or tractor including lift and towing; Pump tender;
- Small trencher and other equipment 30 HP and under

Other equipment may be added to the above list by agreement between Company and Union.

G. C. Field**person**[man] may be required to perform the following duties:

- Performs metalman duties
- When working as a part of a crew, performs carpenter work such as simple form work, scaffolds, and other simple sawing and nailing of lumber;
- When working as a part of a crew, performs plastic fusion such as socket joints, service tees and saddle connections on plastic pipe up to and including 4" in diameter. (Street Fitter classification shall be used when butt fusing or working alone.)
- When working as a part of a crew, performs miscellaneous pipe fitting on service connections/alterations. Such work is limited to threaded pipe under two-inch diameter, length of pipe and fittings not to exceed five feet in length including fitting(s) where the installation is a single domestic meter set without a manifold. (Where the installation requires pipe size of two-inch or larger, length including fitting(s) exceeds five feet, number of meters exceeds one, or a manifold is required, the Street Fitter classification shall be used.)

Class A California drivers license and/or other appropriate licenses and endorsements as required. Company shall pay all costs associated with obtaining and maintaining the appropriate drivers license and/or endorsements.

Incumbent employees who do not currently possess a Class A California drivers license shall not be required to obtain such license, but may do so voluntarily, at Company expense. Should such employee not possess a Class A California drivers license, such employee shall not be assigned to equipment requiring said licenses.

Current employees as of January 1, 1991, in classifications higher than the Field**person**[man] who are subsequently affected by Title 306 will not be adversely impacted as a result of the Field**person**[man] licensing requirements.

Employees who enter the Field**person**[man] classification after the implementation date of January 1, 1991 will be required to possess the Class A California drivers license and/or other appropriate licenses and endorsements as required. If after entering the classification, the employee can no longer meet the physical requirements for the Class A California drivers license and/or other appropriate licenses and endorsements as required, but is otherwise qualified to perform the duties required of a Field**person**[man] on a regular basis, he/she will be accommodated as follows:

One unlicensed Field**person**[man] per 20 licensed **Fieldperson**[man]. In computing this ratio, all Field**person**[man] will be included (both those classified at the time of implementation and Field**person**[man] entering the classification after implementation).

#### **1646 - MISCELLANEOUS EQUIPMENT OPERATOR**

Will replace the following classifications:

0435 Special Driver  
0457 Line Truck Driver  
0461 Heavy Truck Driver  
1640 Miscellaneous Equipment Operator A  
1844 Tractor Operator C  
1570 Compressor Operator A

Class A California driver's license and/or other appropriate licenses and endorsements as required. Company shall pay all costs associated with obtaining and maintaining the appropriate drivers license and/or endorsements.

Incumbent employees who do not currently possess a Class A California driver's license shall not be required to obtain such license, but may do so voluntarily, at Company expense. Should such employee not possess a Class A California driver's license, such employee shall not be assigned the duties of the former Heavy Truck Driver, Line Driver or Special Driver classification.

Current employees as of January 1, 1991, in classifications higher than the Miscellaneous Equipment Operator who are subsequently affected by Title 306 will not be adversely impacted as a result of the MEO licensing requirements. Employees in classifications higher in the Line of Progression to the MEO may voluntarily elect to maintain a Class A driver's license, in which case all costs for obtaining and maintaining shall be paid by Company. An employee who progresses to a classification higher than MEO, in the event of a demotion pursuant to Title 306, shall be allowed up to 60 calendar days to obtain a Class A driver's license if such employee does not already possess such license.

Miscellaneous Equipment Operator - Wage Rate

	(Effective 1/1/90)	(Effective 1/1/91)
Start:	\$723.80	750.95
6 Mo.:	742.35	770.20

MISCELLANEOUS EQUIPMENT OPERATOR (Classification Code 1646)

Operates the following equipment:

- Dozer, smaller than D-4- or equivalent, with or without a side boom or equipment;
- Rough terrain crane, Grove, Drott, Pettibone, up to and including 5 ton;
- Loader, P.T., 1 1/2 thru 3 cu. yds., without sideboom;
- Crane, swing, self-propelled, up to and including 5 ton;
- Transport truck and trailer engaged in loading, transporting, and unloading heavy construction equipment throughout a geographic area or the company system;
- Truck tractor operator coupled with one or more trailers;
- Three-axle truck;
- Truck with derrick and special body complete with tools and equipment to perform all phases of electric line work;\*
- Boom truck without a personnel bucket under 10 tons;\*\*
- Hydrauger;



- \* See Line Department Lines of Progression Chart, Note 7
- \*\* See Station/Hydro Department Lines of Progression Chart, Note 8

- Gas/electric hoist over 15 HP;
- Motor Patrol, less than 115 HP, when not grading to stake or grade;
- Trencher, Boom Type, such as Ditch Witch, or equivalent;
- Concrete Pump;
- Tensioners and Pullers (see separate listing of pulling and tensioning equipment);
- Large Snow Cats;
- Drill, Liner, self-propelled air trac or equivalent;
- Cross Country vehicles such as Dragon Wagon or equivalent;
- Flume washer.

Other equipment may be added to the above list by agreement between Company and Union.

[Tractor Operator B]  
[Tractor Operator A]

#### **1840 - TRACTOR OPERATOR**

Eliminate the present Tractor Operator B and Tractor Operator A classification title, establish a new Tractor Operator classification title utilizing existing Tractor Operator A classification code of (1840)

All employees currently classified as Tractor Operator B and Tractor Operator A shall be assigned to the Tractor Operator classification and wage rate.

Tractor Operator - operates the following equipment:

- Cat, D-4, D-5, D-6, D-7 and D-8;
- Case, 850, 1150;
- IH, TD-9, TD-15, TD-20, TD-25;;
- C., HD-6, HD-11, HD-16, HD-21;
- Drott over 5 ton to 18 ton,
- Crane, swing, self-propelled 5 to 10 ton P/M Model 25-20;
- Loader, crawler mounted, 1-1/2 cubic yard and over;
- Whirley, swing crane;
- Motor patrol over 115 HP or when grading to stakes or grade;
- Tractor, crawler side boom, 10 ton and over.

Other equipment may be added to the above list by agreement between Company and Union.

EXHIBIT I

Delete the following classifications due to obsolescence:

Service Center

0856 - Working Foreman "C"

Field Classifications

0050 - Engineer's Aid  
0165 - Carpenter C  
0415 - Truck Driver  
0435 - Special Truck Driver  
0457 - Line Truck Driver  
0461 - Heavy Truck Driver  
0520 - Faller  
0523 - Second Faller  
0910 - Groundman  
0915 - Steel Assembly Groundman  
0947 - Utility Worker [Helper]  
1040 - Jackhammerman  
1080 - Laborer  
1205 - Material Man  
1450 - Metalman  
  
1570 - Compressor Operator A  
1573 - Compressor Operator B  
1640 - MEOA  
1643 - MEOB  
1644 - MEOC  
1843 - Tractor Operator B  
1844 - Tractor Operator C  
1970 - Pipe Wrapper, Hand Large  
1975 - Pipe Wrapper, Hand Small  
1980 - Powderman

**LIST OF DOCUMENTS/REASONS PROMPTING CHANGES**

<b>REFERENCE</b>	<b>Subject</b>	<b>Page(s)</b>
LA 13-70 9/11/13	Added Water Systems Repairperson and Appr. Water Systems Repairperson classifications.	8-9
LA 13-23 5/1/13	Established the Electrical Technician job definition.	7
LA 12-32 1/17/13	Added letter agreement regarding Commercial Driver's License Addendum.	53-58
LA 09-31 7/29/09	Added letter agreement regarding Apprentice Communications Technician entrance exam.	51-52
LA 08-37 12/18/08	Added letter agreement regarding co-mingling Title 200 and Title 30 for ISTS assignments.	49-50
LA 07-43 11/29/07	Added letter agreement regarding Apprentice Electrical Technician entrance exam.	39-48
LA R1-06-32 2/26/07	Established the Title 300 (50107750) Utility Worker-Communications.	2-3
LA R1-04-11 1/6/05	Added letter agreement regarding Switchman Certification Program.	37-38
R1-01-38 9/20/01	Revises Item III of Letter Agreement 84-40.	27-36
LA R1-99-57 4/3/00	Added letter agreement regarding co-mingling Title 200 and 300 Apprentice Electricians.	25-26
LA 97-140 12/10/97	Added letter agreement regarding staffing during a temporary need.	23-24
LA 93-69 10/15/93	Added letter agreement for historical purposes regarding GC classification consolidation. Deleted this information from the beginning of the JDLOP.	59-66
LA 93-39 5/1/95	Added letter agreement regarding driver's license requirements.	16-18
LA R1-90-183 10/24/90	Added Materials Handler and Lead Materials Handler job definitions and deleted the letter agreement.	6
LA R2-90-40 6/29/90	Added Telecommunications Equipment Installer and deleted letter agreement. Modifies LA R2-85-112.	6-7
LA 80-39 6/18/80	Deleted letter agreement as LA 84-40 (pages 9-10) supersedes it.	n/a
LA 878 2/13/73	Added Technical Crew Leader A job definition and deleted the letter agreement.	6
LA 798 3/3/72	Added Technical Crew Leader B job definition and deleted the letter agreement.	6